

*Timo flat / 170 / 21*

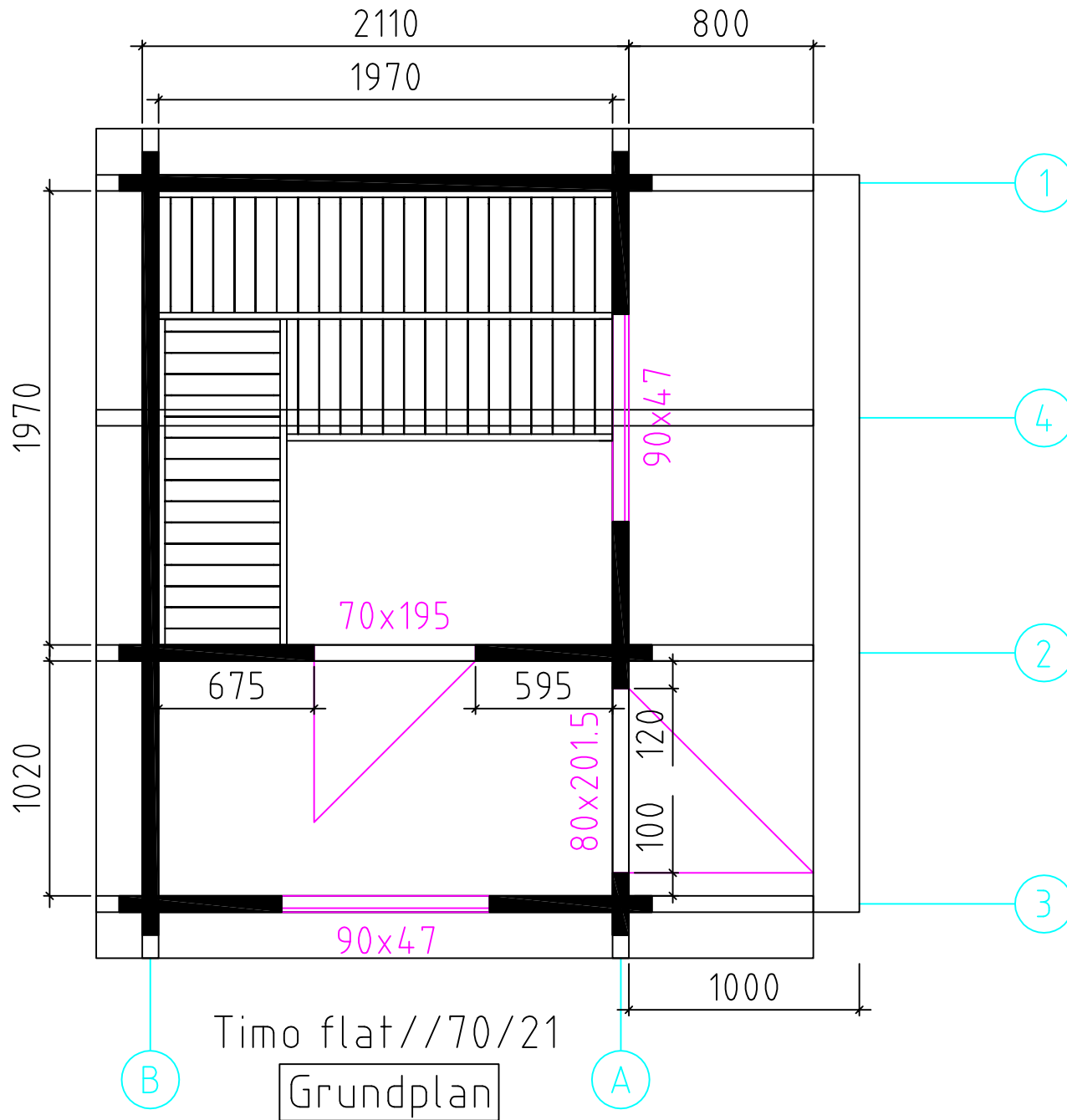

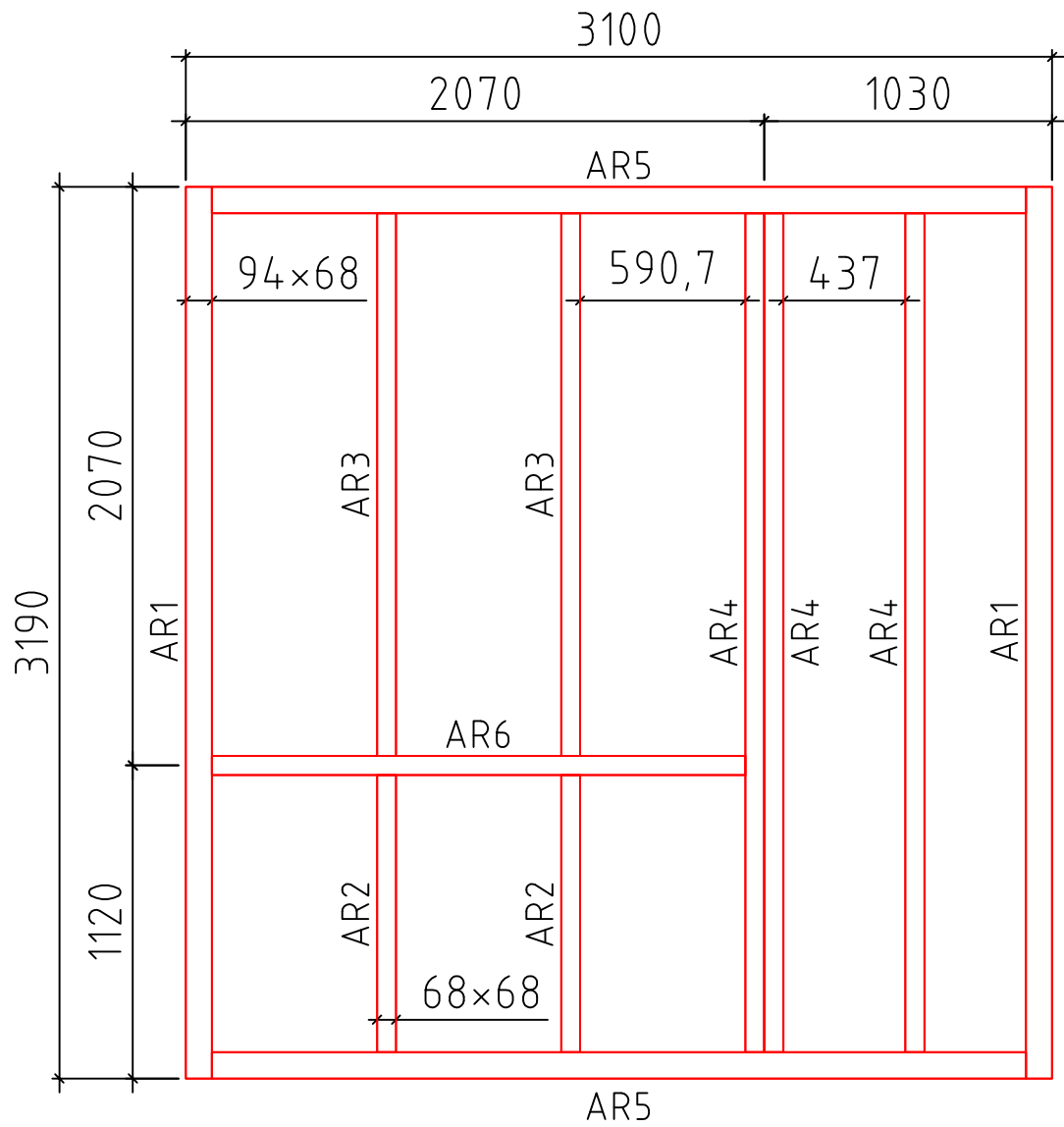

Timo flat//70/21

Fundament

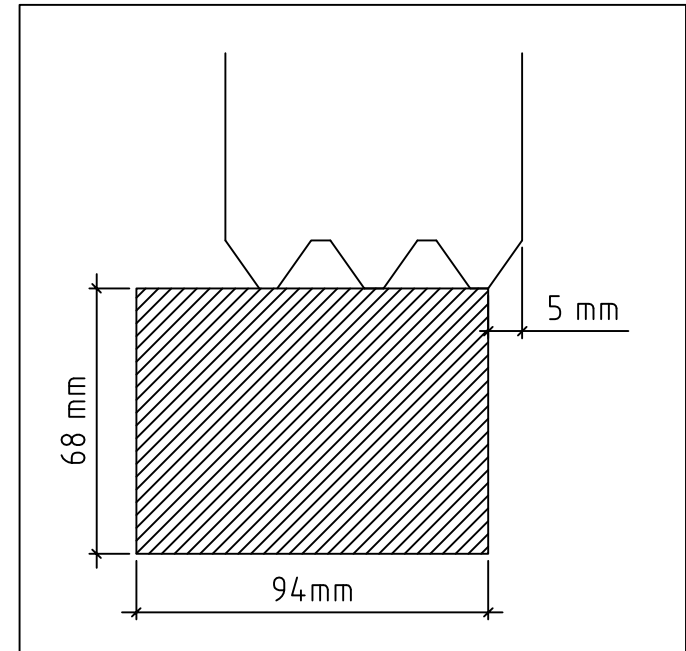

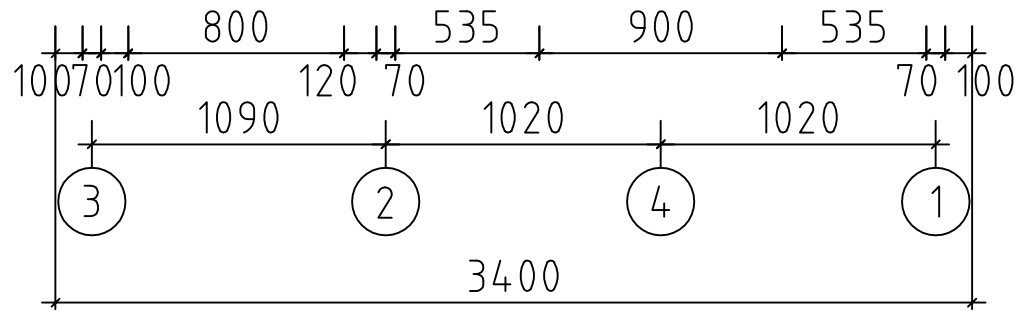
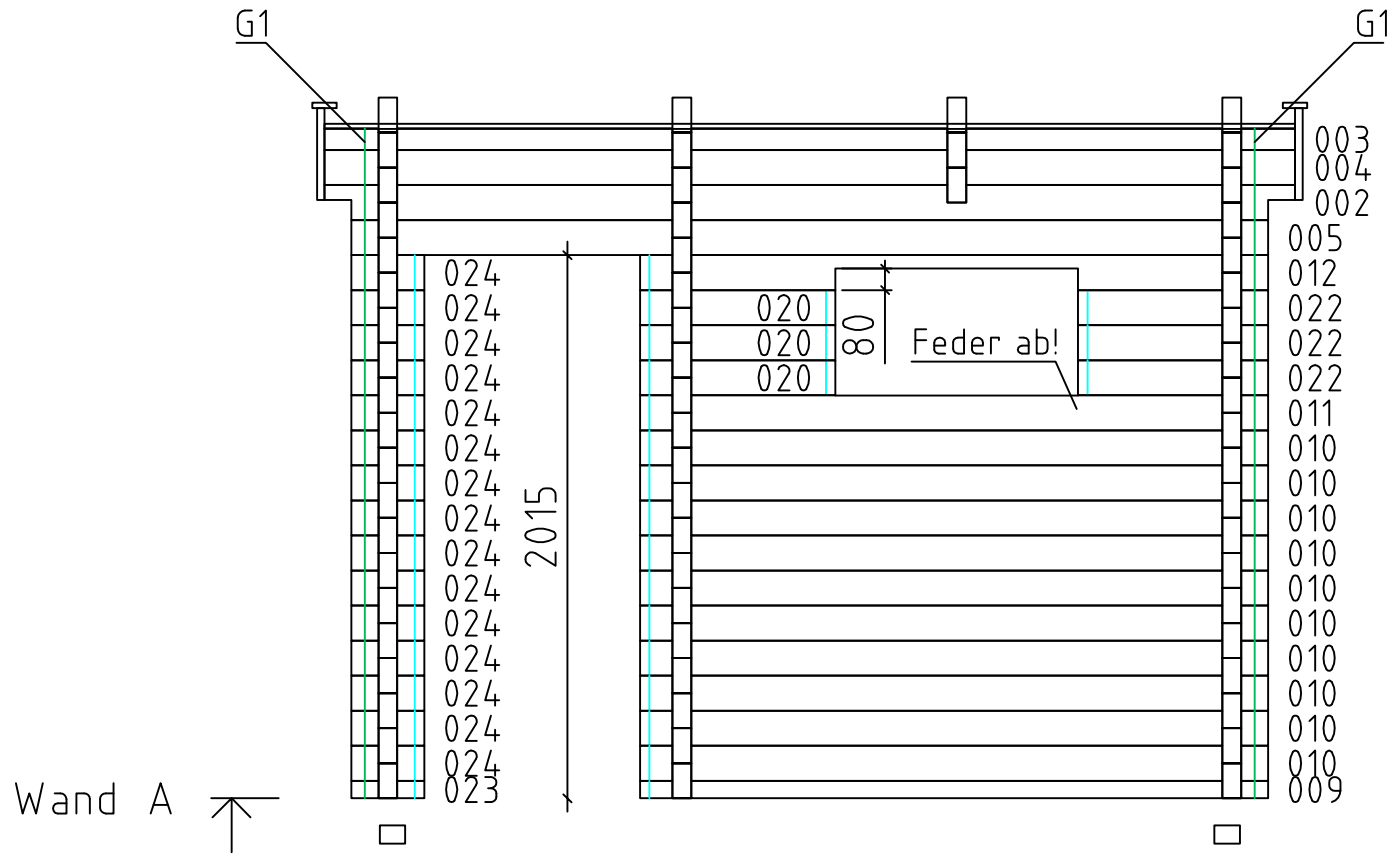

Timo flat//70/21

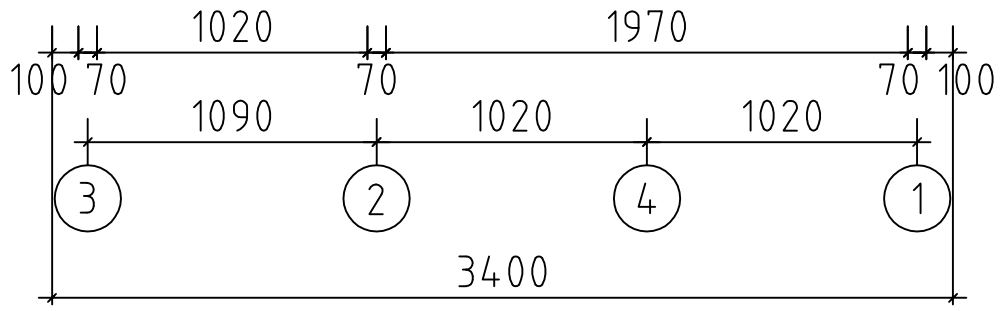
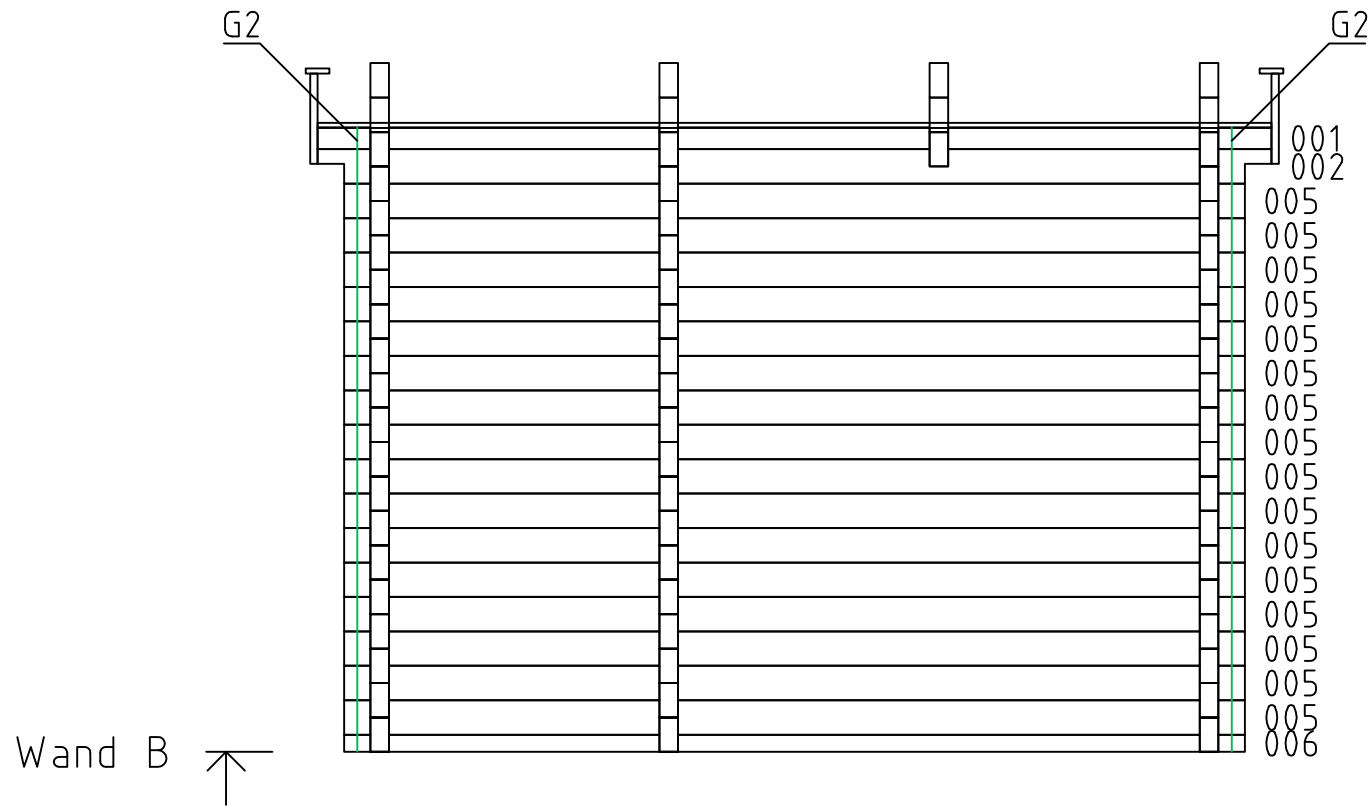

Timo flat//70/21

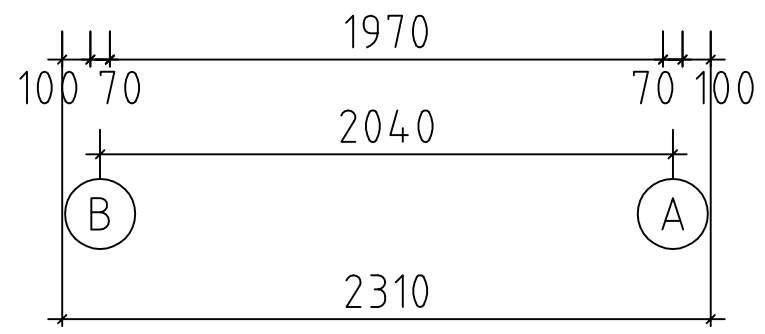
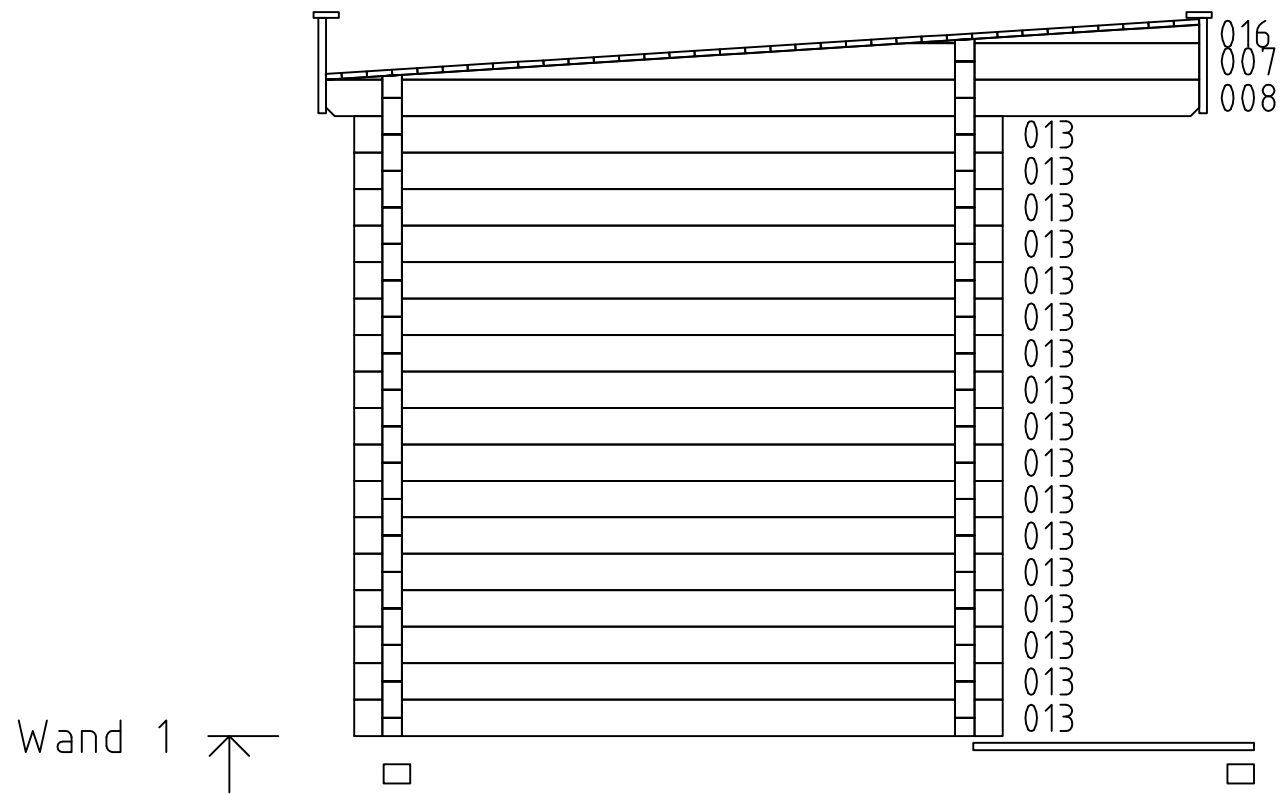

Timo flat//70/21

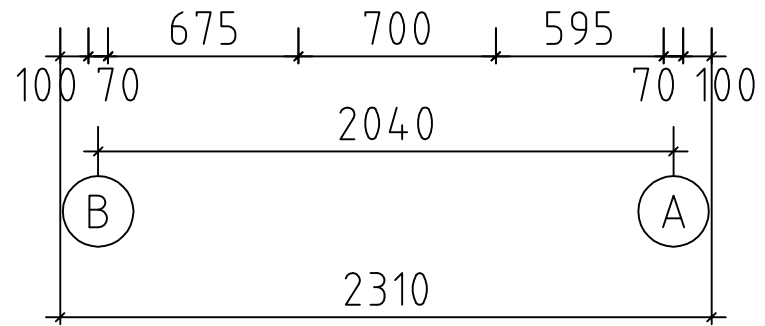
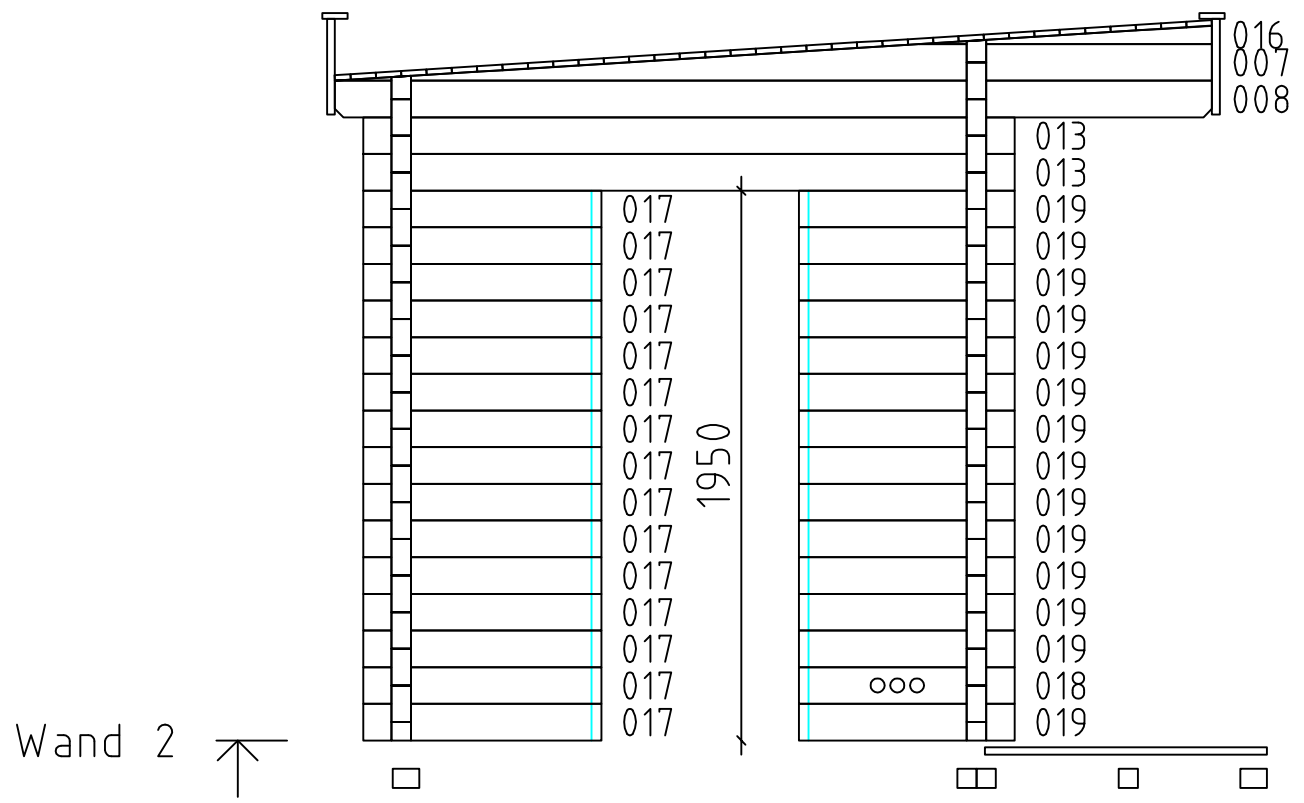

Timo flat//70/21

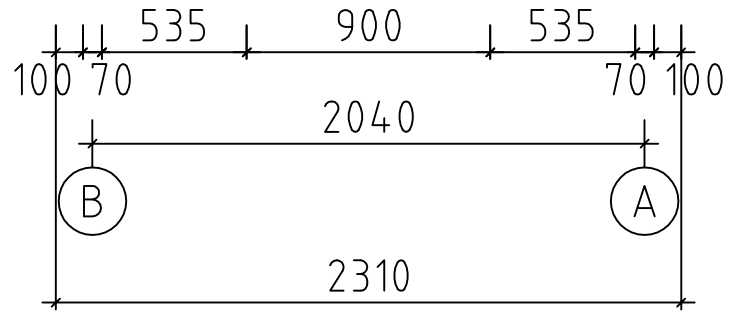
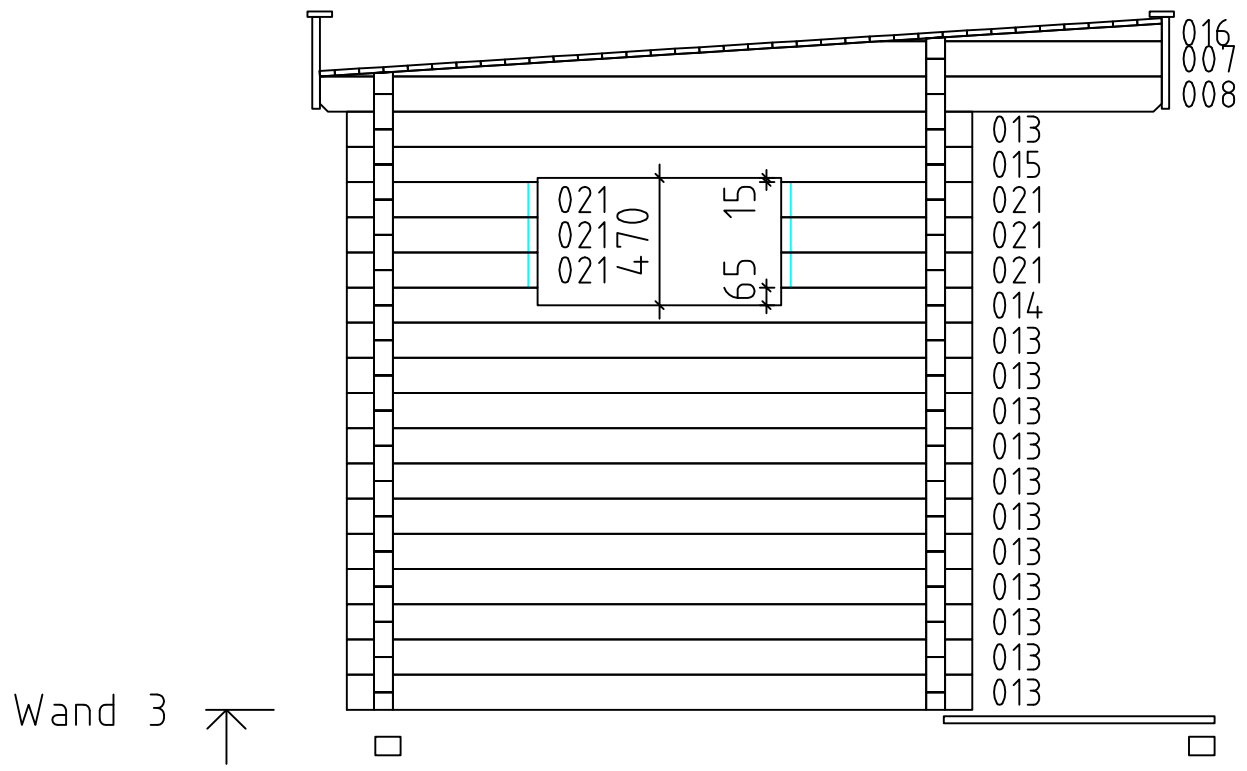

Timo flat//70/21



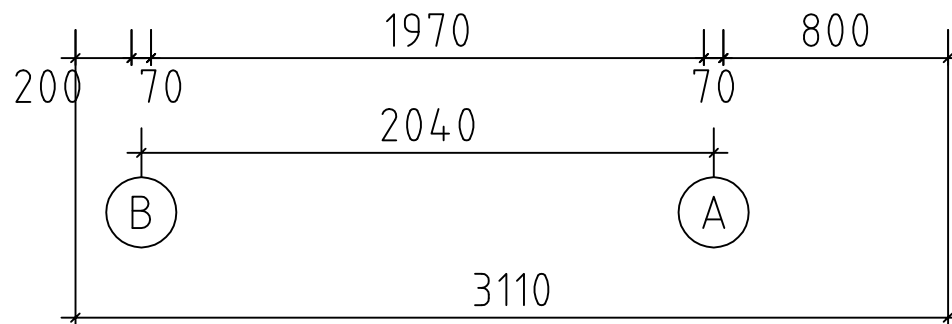
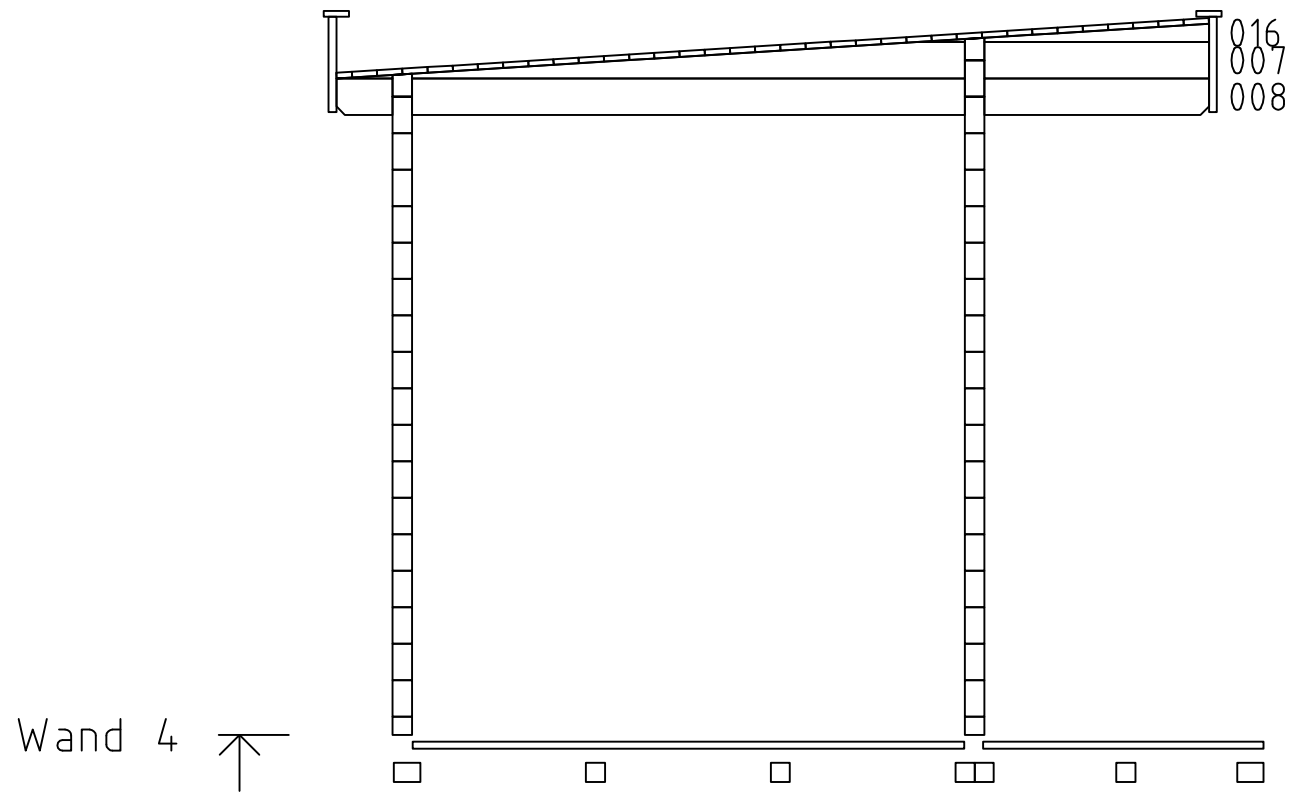



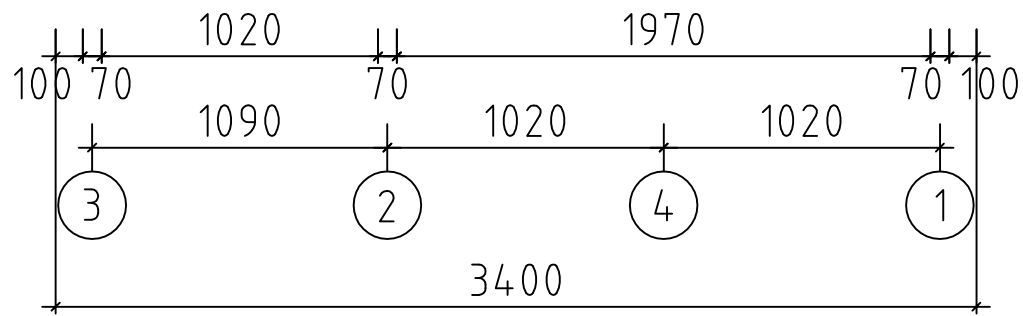
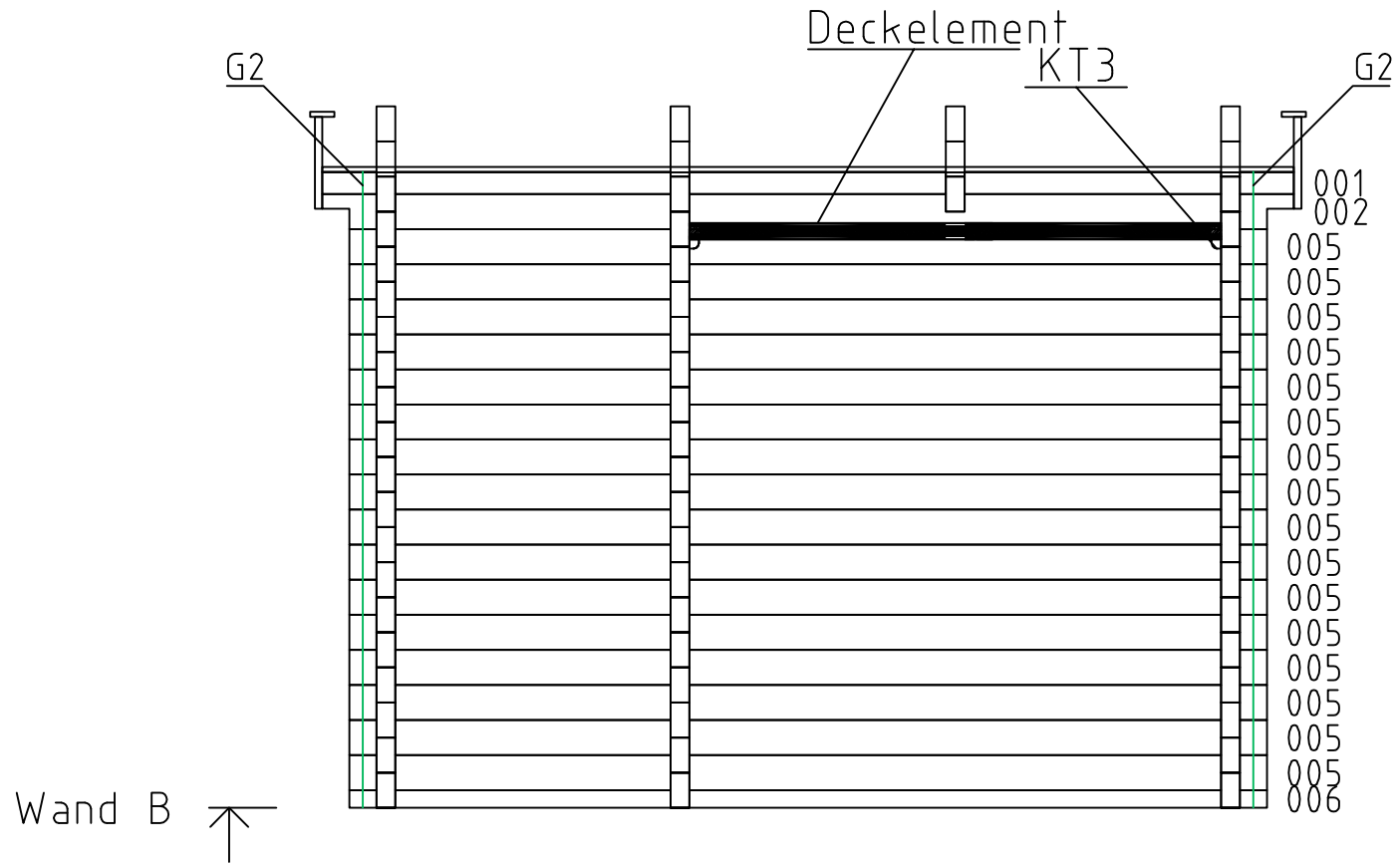



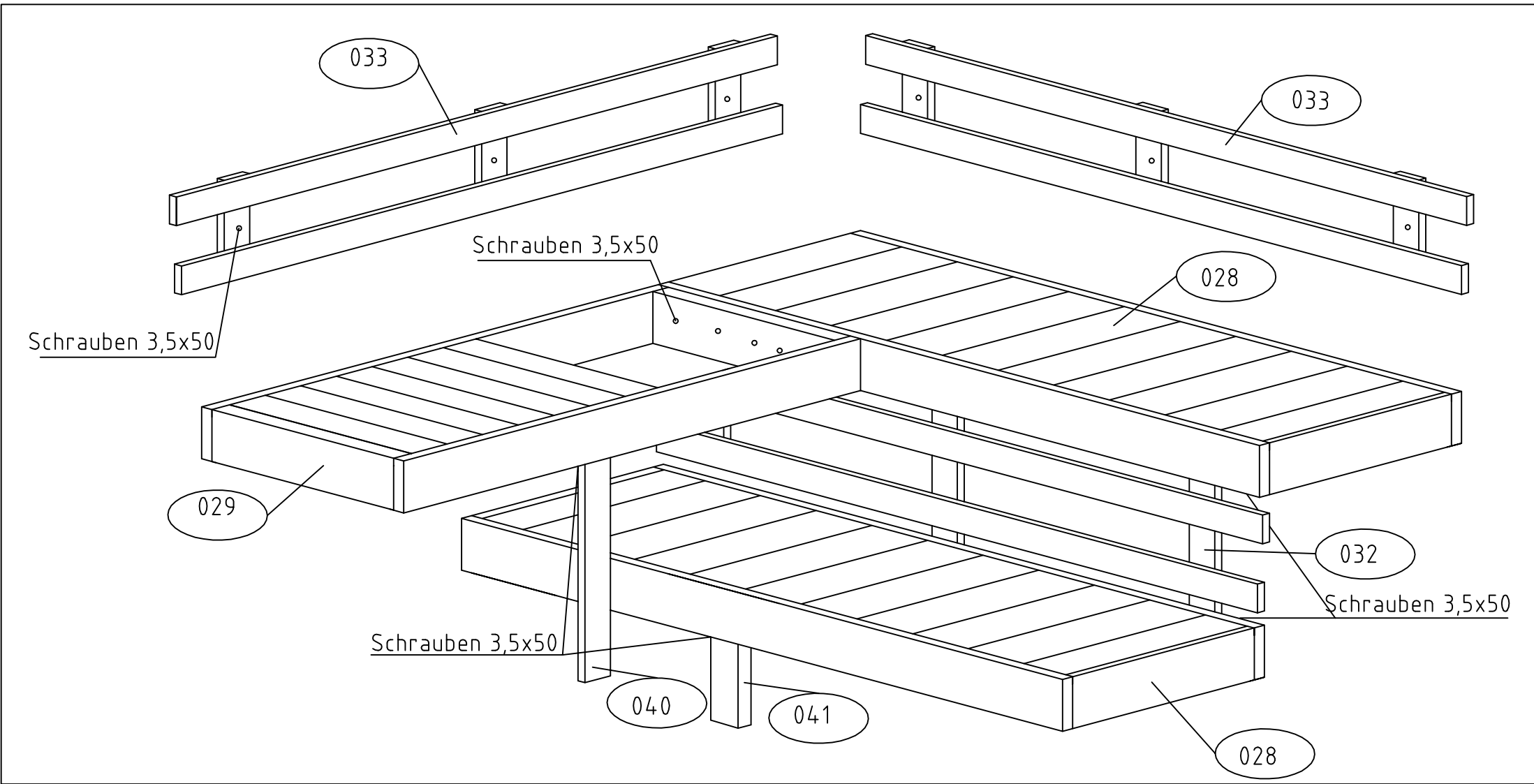



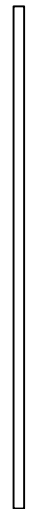
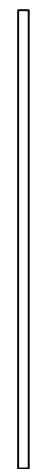
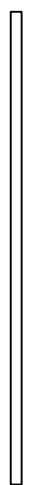

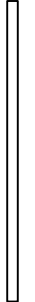
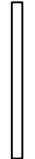
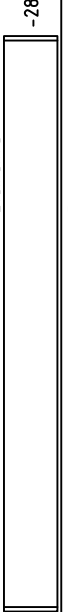
Timo flat//70/21

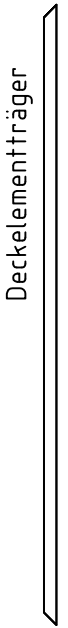
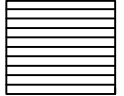

Timo flat//70/21



Pos	Timo flat//70/21	ST	F (mm)	L (mm)
001		1	70x82	3600
002		2	70x130	3600
003		1	70x80	3600
004		1	70x130	3600
005		17	70x130	3400
006		1	70x65	3400
007		4	70x130	3110
008		4	70x130	3110
009		1	70x65	2330
010		10	70x130	2330
011		1	70x130	2330
012		1	70x130	2330
013		31	70x130	2310
014		1	70x130	2310
015		1	70x130	2310
016		4	70x65	1039
017		15	70x130	845
018		1	70x130	765
019		14	70x130	765
020		3	70x130	725
021		6	70x130	705
022		3	70x130	705
023		1	70x65	270
024		15	70x130	270
Kood	Materjal	File	trükk.dwg	Leht 1/3

Pos	Timo flat//70/21	ST	F (mm)	L (mm)
AR1	Fundamentbalken 	2	94x68	3190
AR5	Fundamentbalken 	2	94x68	2912
AR4	Fundamentbalken 	3	68x68	3002
AR3	Fundamentbalken 	2	68x68	1942
AR6	Fundamentbalken 	1	68x68	1908
AR2	Fundamentbalken 	2	68x68	992
vÖ1	Elemente 	2	28x340	3656
vÖ2	Elemente 	2	28x340	3130
HL1	Handlauf 	2	90x20	3690
HL2	Handlauf 	2	90x20	3200
KT3	Deckelementträger 	4	35x35	1970
054	Deckelement 	1+1		
0203	Fussbodenbretter 	34	90x26	1966
	Terrassenbretter 	34	90x26	1000
	Dichtungsband		4x80	10lfm
	Dachbretter 	35	90x20	3600
	Abdeckleiste 		20x40	24lfm
G1	Gewindestift 12 	2		2550
G2		2		2400
Kood	Materjal	File	trükk.dwg	Leht 2/3

Pos	ST	F (mm)	L (mm)
028	2		1968
029	1		1412
037	2	44x68	1100
038	1	44x68	700
039	2	44x68	576
040	1	44x68	841
041	1	44x68	360
032	1		
033	1+1		
034	1		
035	2		
046	50	4,5x70	
047	50	3,5x50	
048	20	4x80	
048	50	4,5x70	
Fundament	20		
Fussboden	350		
Dach	120		
Montage	30		
	40		
Kood			

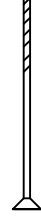
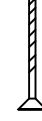
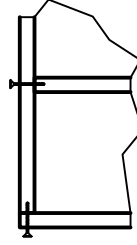
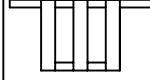
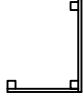
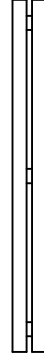
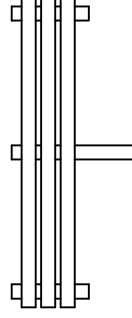

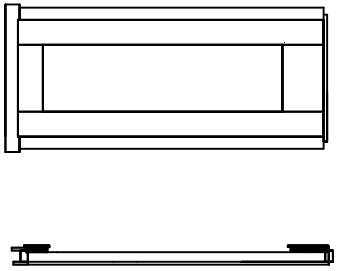
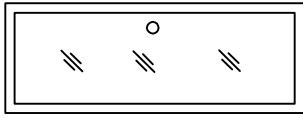
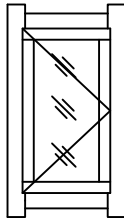
Pos	Timo flat//70/21	ST	F (mm)	L (mm)
T1	<p>Tür 800x2015</p> <p><span style="border: 1px solid black; padding: 2px;">AB</span></p>  <p><span style="border: 1px solid black; padding: 2px;">ISO</span></p> <p>Tenderleiste 23x23x1980=2tk</p> <p>Kotike</p>	1L		
T2	<p>Tür 700x1950</p> <p>Alumise pakuga</p>  <p>Klaasuks pronksivärvi</p> <p>Tenderleiste 23x23x1920=2tk</p>	1L		
F1	<p><span style="border: 1px solid black; padding: 2px;">AB</span></p> <p>Fenster 900x470</p>  <p>Väljapoole avanevad klappfensterid</p> <p>1 kremoniga ja fiksaator kaasa</p> <p>ISO=</p>	2		
Kood	Materjal	File	trükk.dwg	Leht 2/3