

*Sauna Timo / 150 / 20*

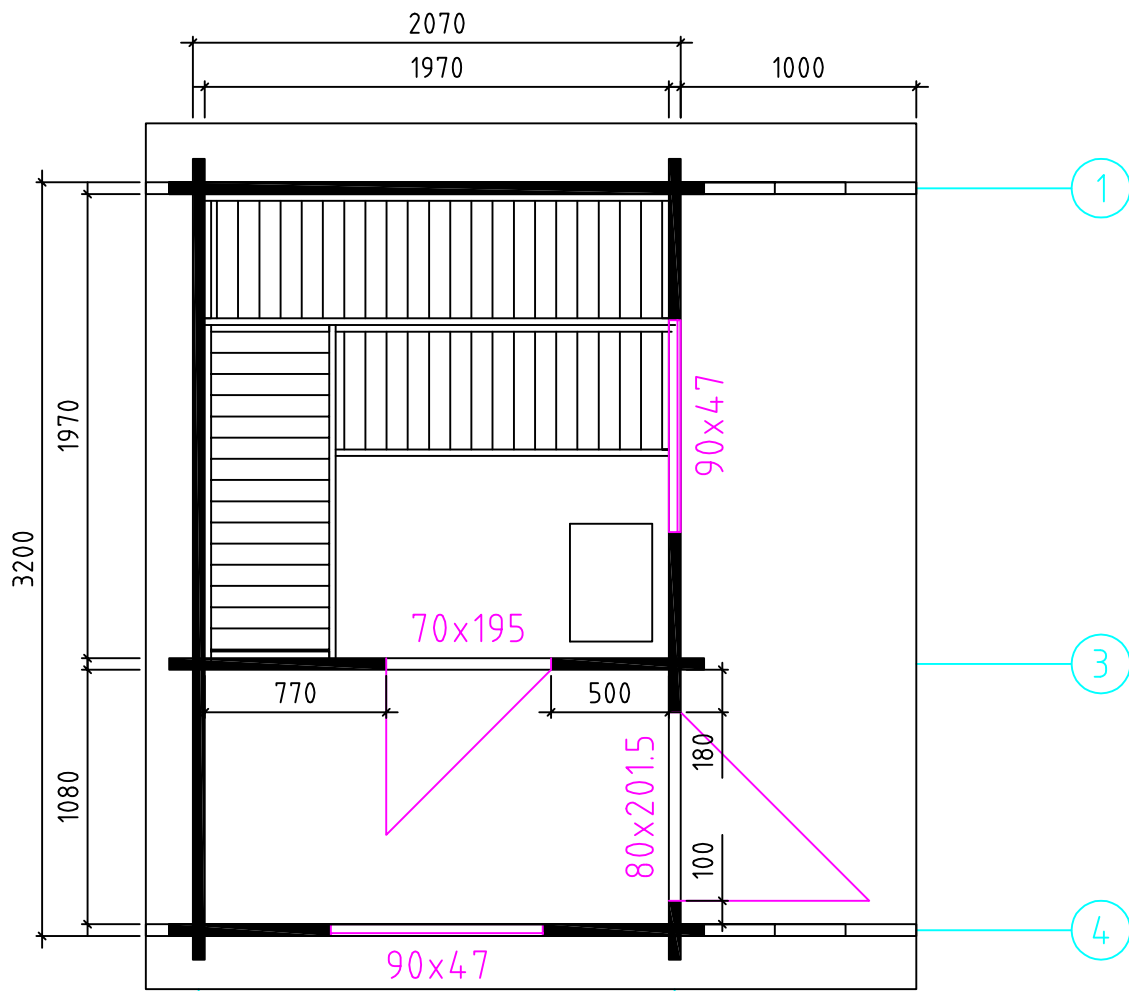

Sauna Timo//50/20

Grundplan

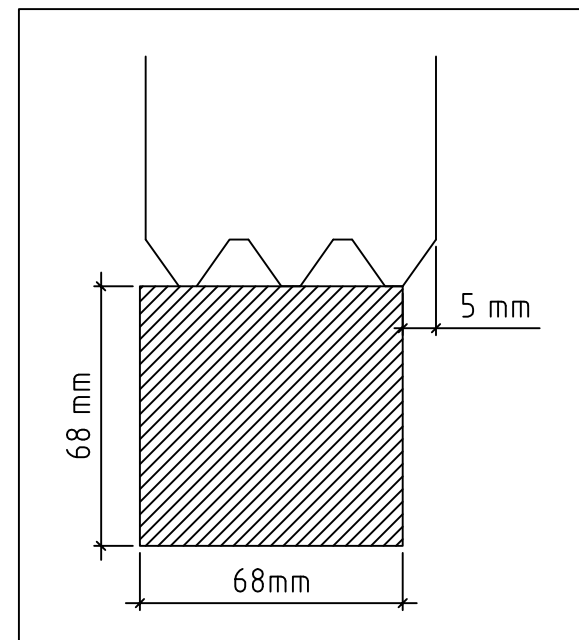
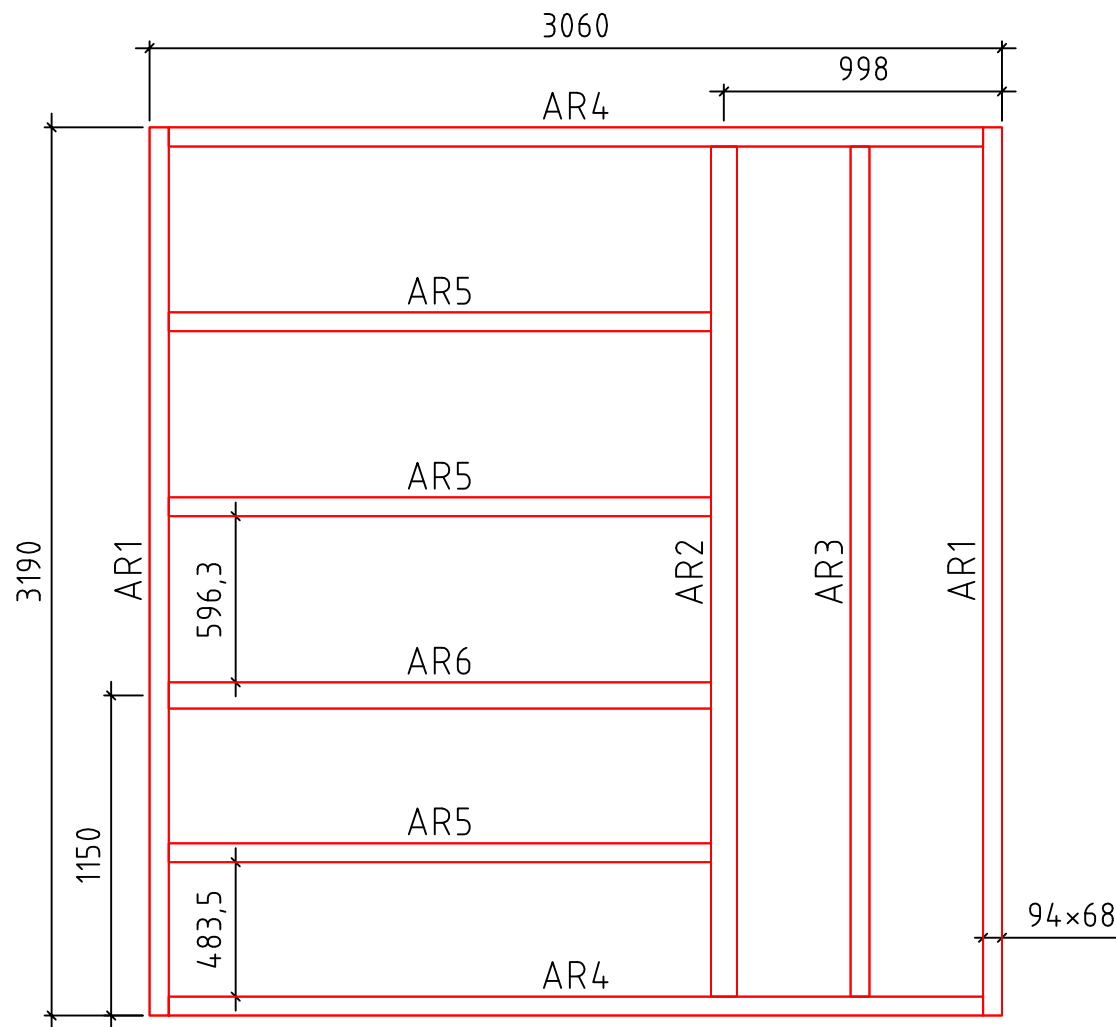

Sauna Timo//50/20

Fundament

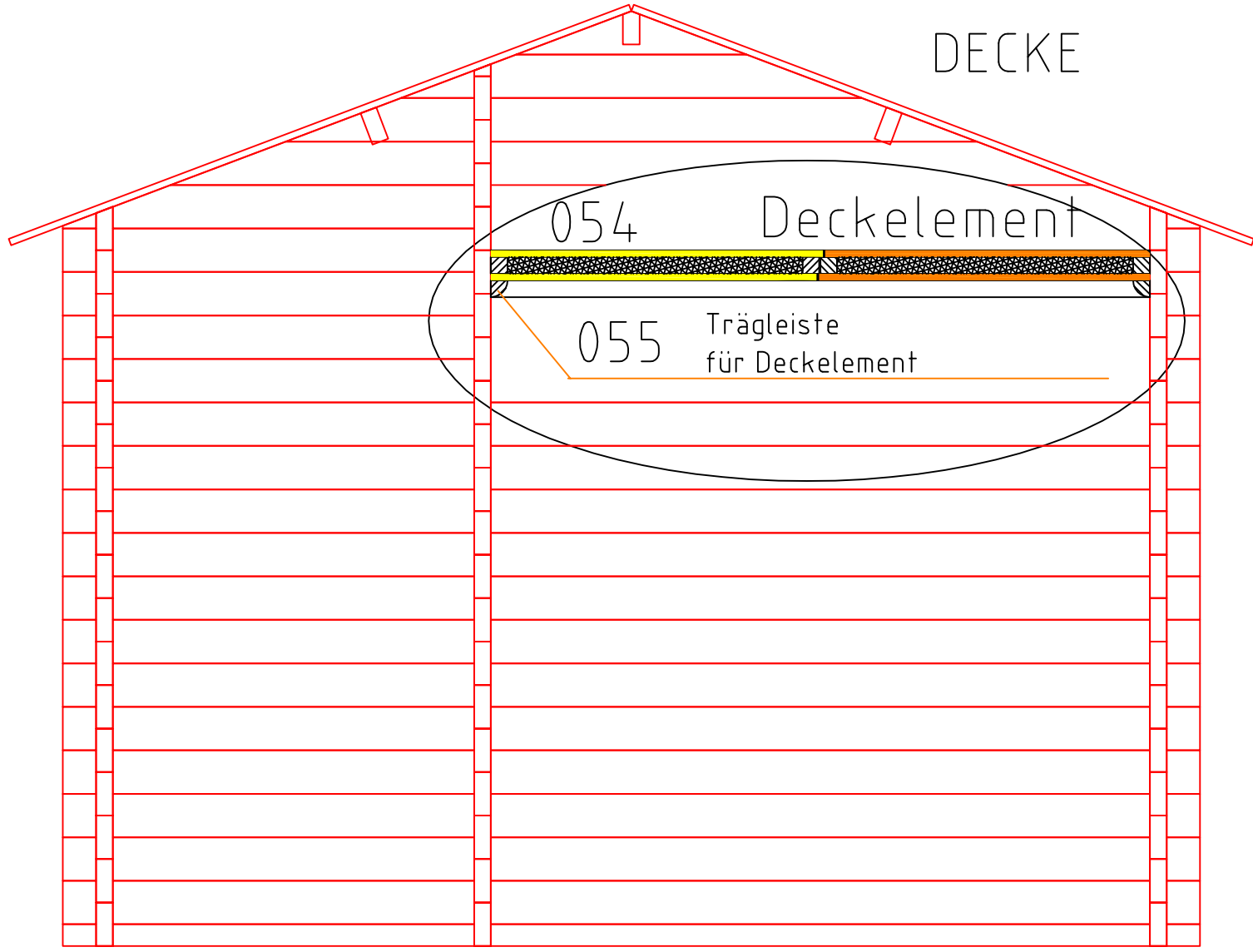

Sauna Timo//50/20

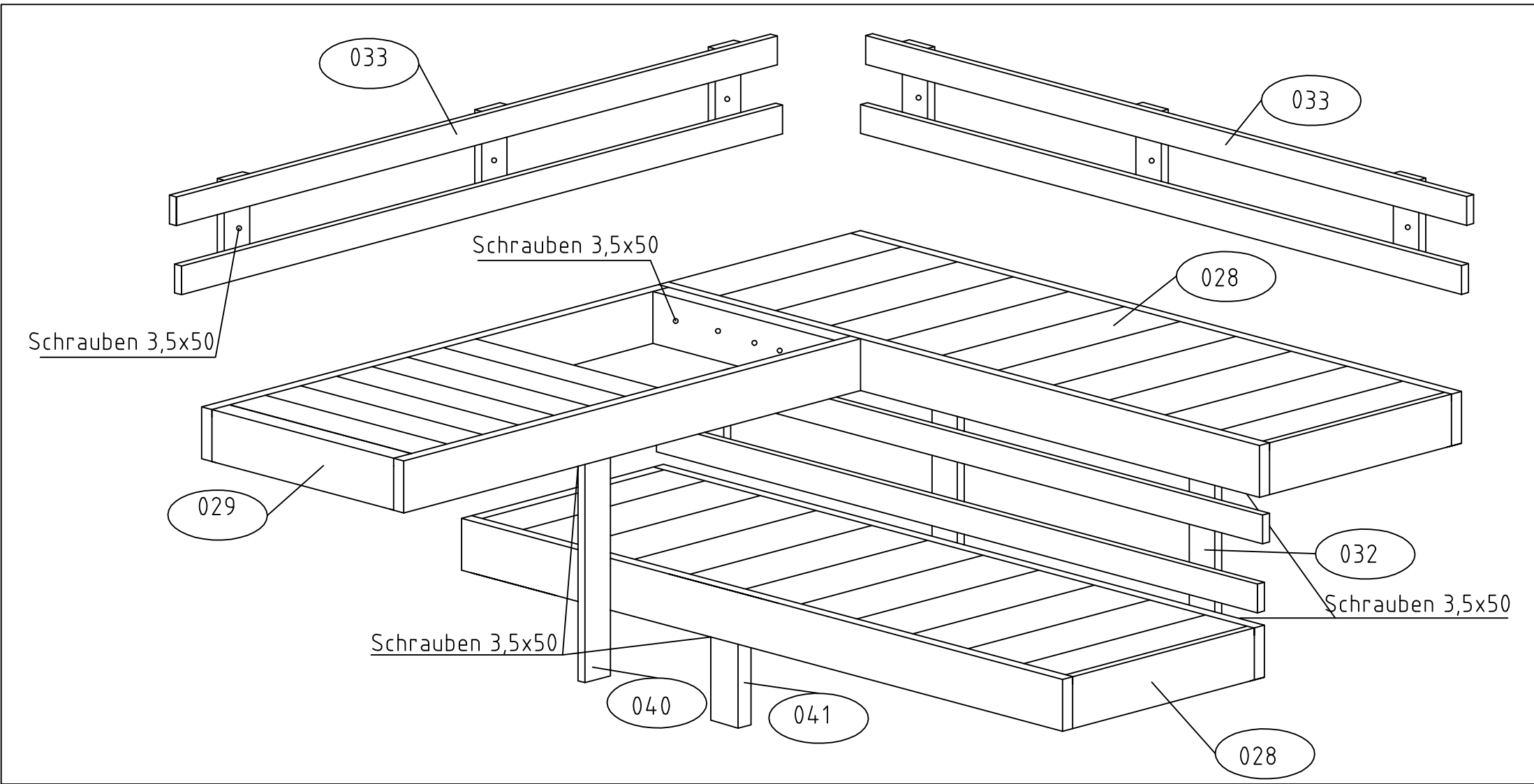

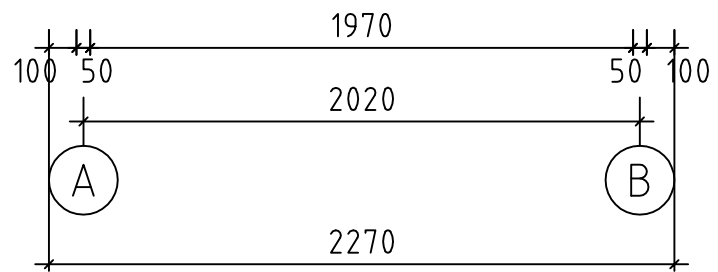
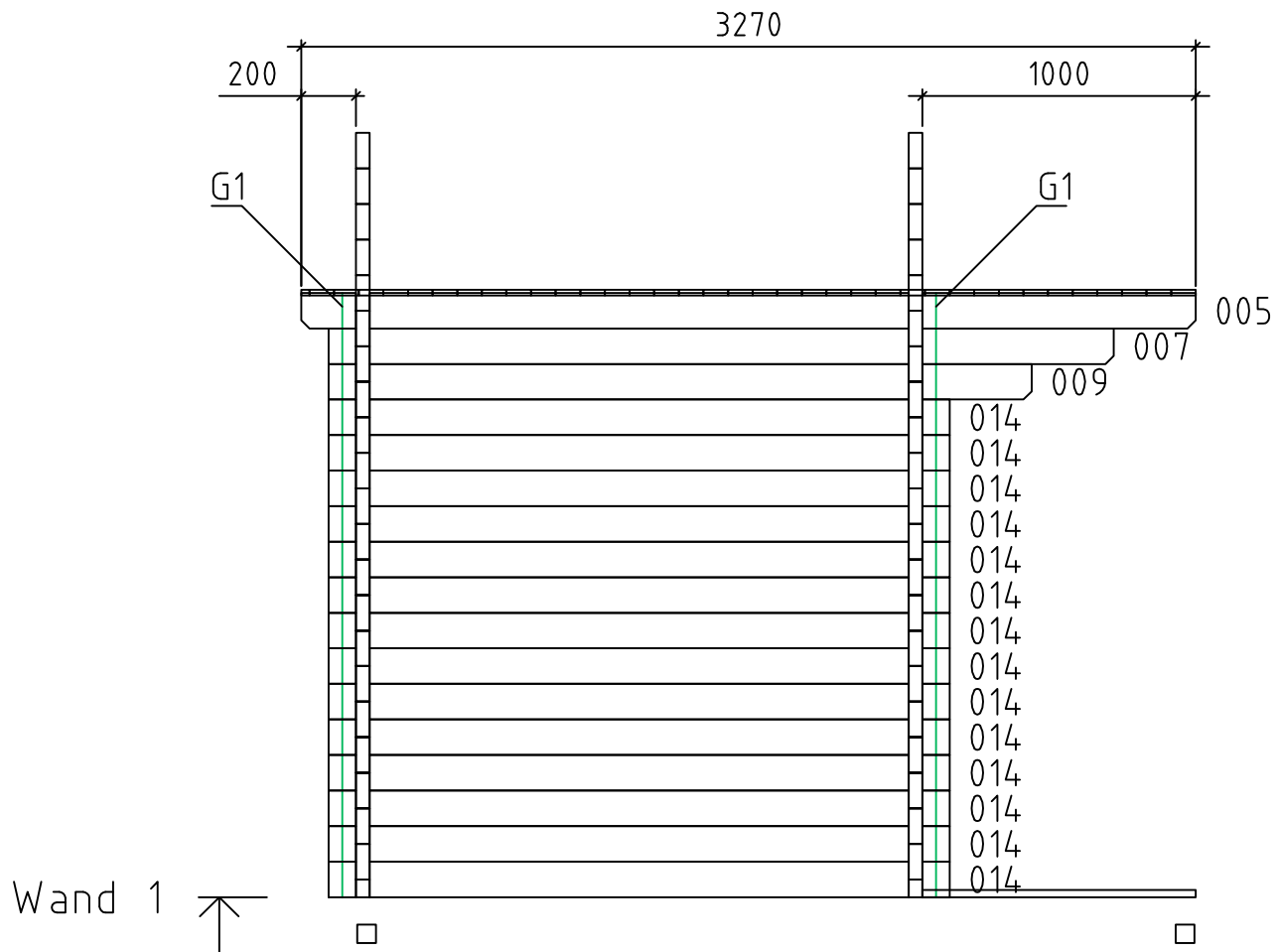

Sauna Timo//50/20

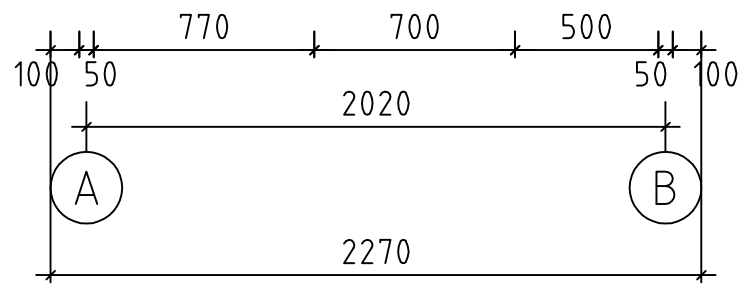
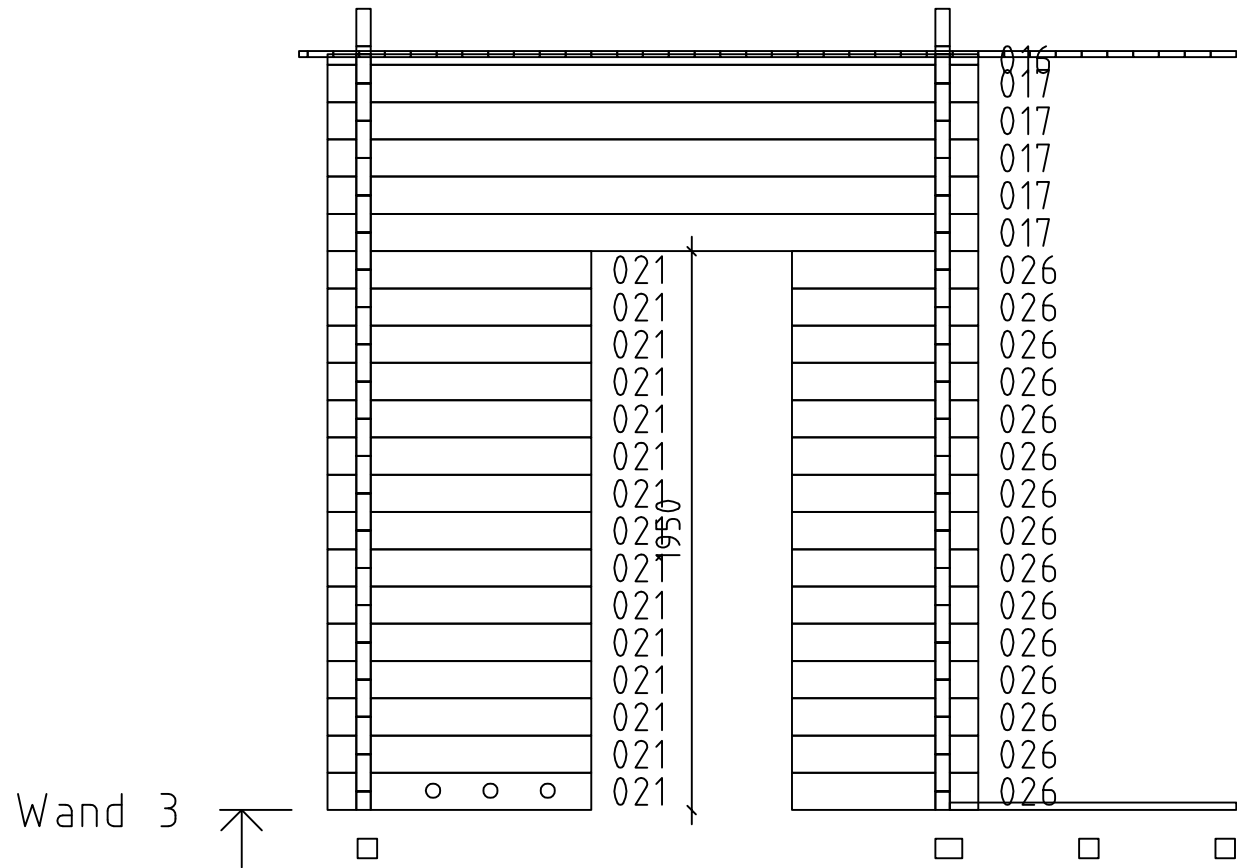

Sauna Timo//50/20

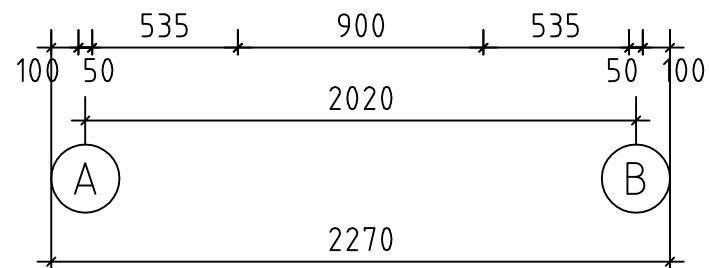
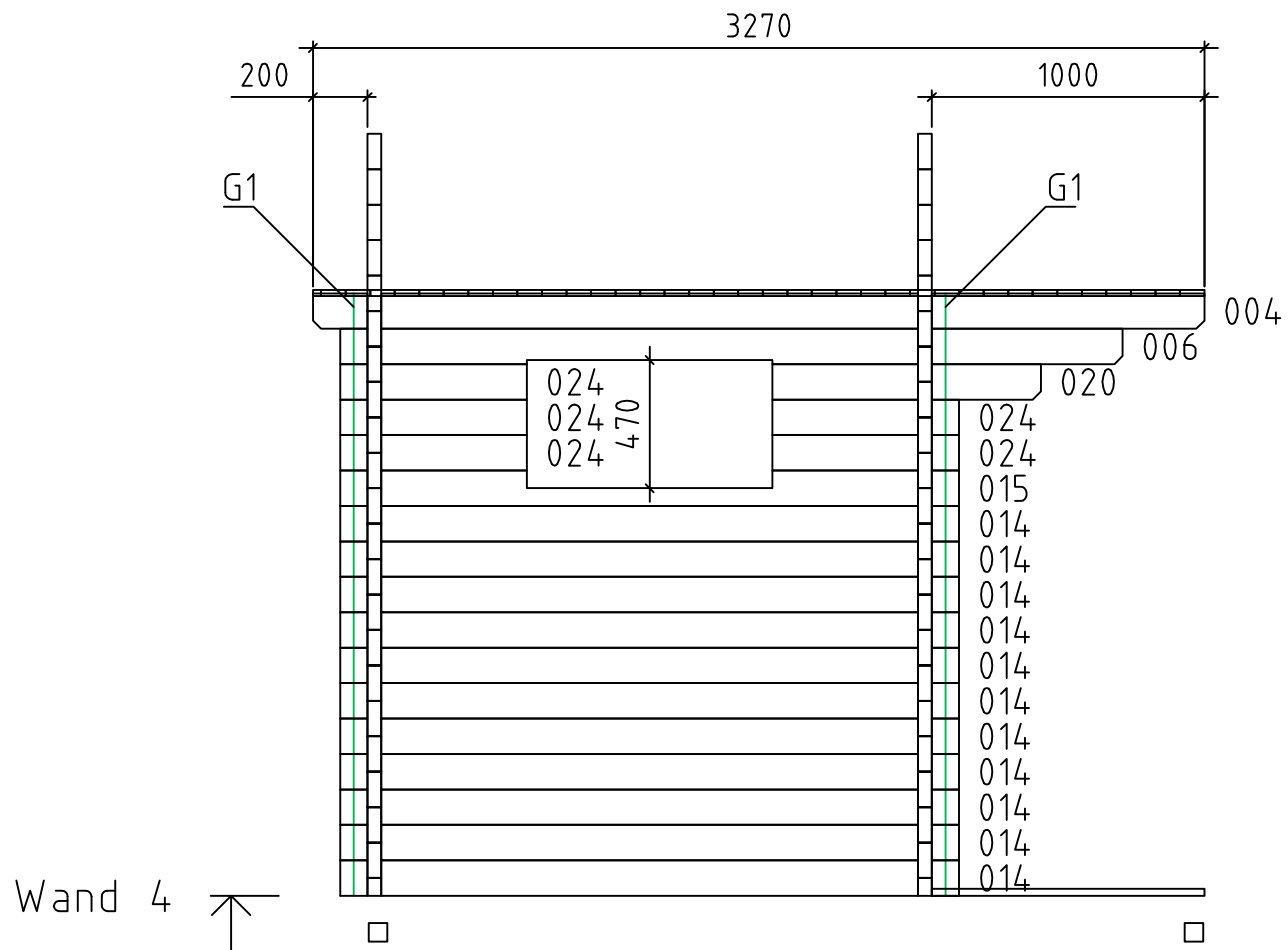

Sauna Timo//50/20



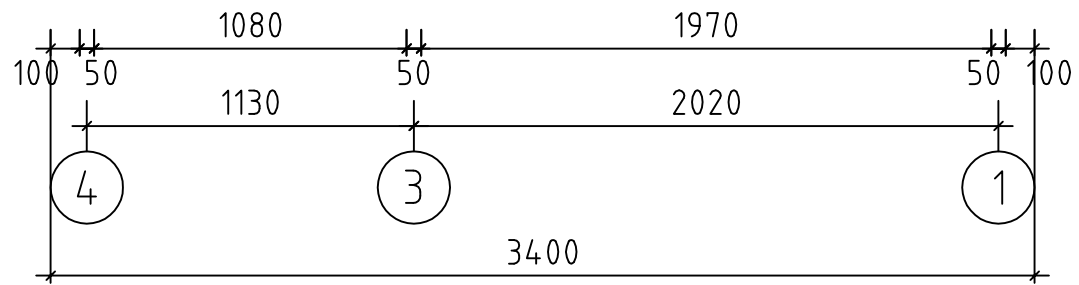
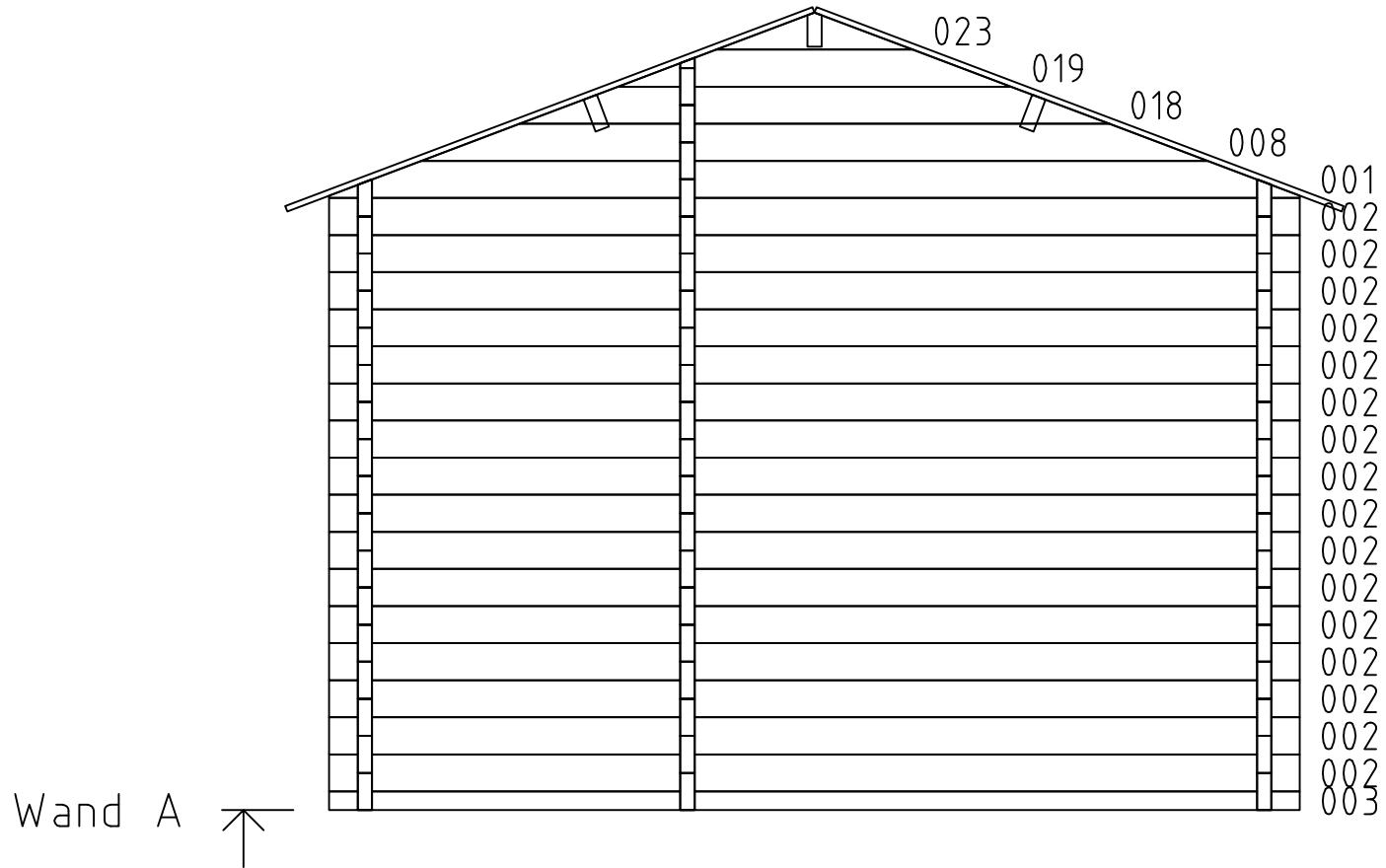



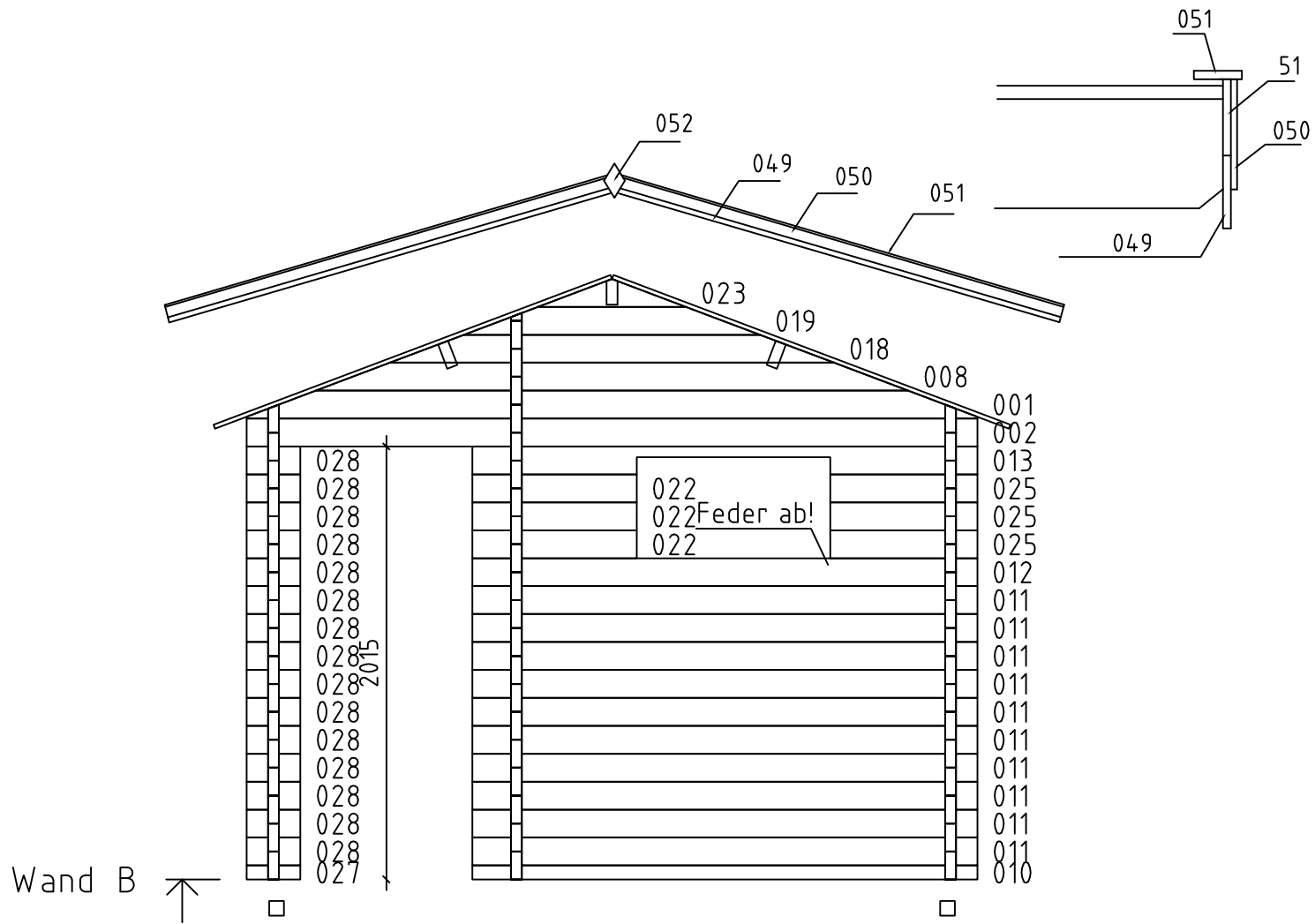





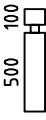



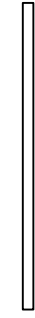
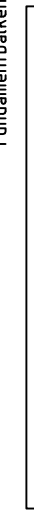
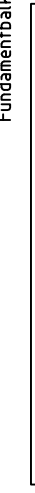





Sauna Timo//50/20





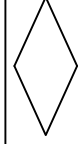

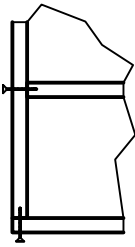

Sauna Timo//50/20

Pos	Sauna Timo//50/20		ST	F (mm)	L (mm)	
001			2	50x130	3400	
002			17	50x130	3400	
003			1	50x65	3400	
004			1	50x130	3270	
005			1	50x130	3270	
006			1	50x130	2870	
007			1	50x130	2870	
008			2	50x130	2756	
009			1	50x130	2570	
010			1	50x65	2350	
011			10	50x130	2350	
012			1	50x130	2350	
013			1	50x130	2350	
014			25	50x130	2270	
015			1	50x130	2270	
016			1	50x36	2270	
017			5	50x130	2270	
018			2	50x130	2067	
019			2	50x130	1378	
020			1	50x130	985	
021			1+14	50x130	920	
022			3	50x130	765	
023			2	50x130	689	
024			5	50x130	685	
025			3	50x130	685	
Kood		Materjal	File	trükk.dwg	Leht	1/3

Pos	Sauna Timo//50/20		ST	F (mm)	L (mm)
026			15	50x130	650
027			1	50x65	250
028			15	50x130	250
AR2	 Fundamentbalken	Impr.	1	94x68	3054
AR6	 Fundamentbalken	Impr.	1	94x68	1947
AR1	 Fundamentbalken	Impr.	2	68x68	3190
AR3	 Fundamentbalken	Impr.	1	68x68	3054
AR4	 Fundamentbalken	Impr.	2	68x68	2924
AR5	 Fundamentbalken	Impr.	3	68x68	1947
PR1	 Dachbalken		2	50x140	3270
PR2	 Dachbalken		1	50x140	3270
0203	 Fussbodenbretter		22	90x26	1966
0203	 Fussbodenbretter		22	90x26	1076
	 Abdeckleiste			20x40	29m
	 Dachbretter		74	90x20	1982
	 Terrassenbretter	Impr.	34	90x26	1000
100	 Giebelleiste		4	120x20	2030
101	 Giebelleiste		4	90x20	2030
102	 Giebeldeckleiste		8	60x20	2030
103	 Giebelsegment		2		
104	 Dachpappenleiste		8	40x20	1635
Kood	Materjal	File	trükk.dwg	Leht	2/3

Pos			ST	F (mm)	L (mm)
054	Deckelement (Zwischendeck)		1+1		
055	Trägleiste für Deckelemente Befestigung		4	35x35	1970
028	Liegen		2		1968
029	Aspen		1		1412
037	Träger für Liegen		2	44x68	1100
038			1	44x68	700
039			2	44x68	576
040	Liegenstütze		1	44x68	841
041			1	44x68	360
032	Zwischenbankverkleidung Aspen		1		
033	Rückenlehnen Aspen		1+1		
034	Ofenschutzgitters		1		
035	Kopfstütze Aspen		2		
046	Schrauben für Liegenträger		50	4,5x70	
047	Schrauben für Liegen		50	3,5x50	
048	Schrauben für Ofenschutzgitters		20	4x80	
G1	Gewindestift 12		4		2230
Kood	Materjal	File	trükk.dwg	Leht	3/3

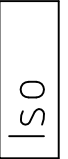
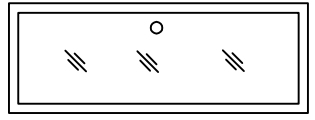
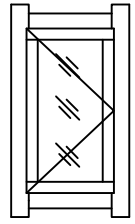
Pos	Sauna Timo//50/20		ST	F (mm)	L (mm)
Fundament		 Schrauben 6x130	20		
Fussboden Dach		 Schrauben 3,5x50	420		
		 Schrauben 4,2x55 (Terrassenschrauben)	120		
Montage	Giebel	 Schrauben 6x130	30		
T1	 Tür 800x2015 	 Kotike	1L		
T2	 Tür 700x1950 Alumise pakuga	Klaasuks pronksivärvi	1L		
F1	 Fenster 900x470 Väljapoolle avanevad klappfensterid 1 kreemooniga ja fiksaator kaasa Iso=		2		
Kood	Materjal	File	trükk.dwg	Leht	2/3