

FH1	28x58x1768	5
-----	------------	---

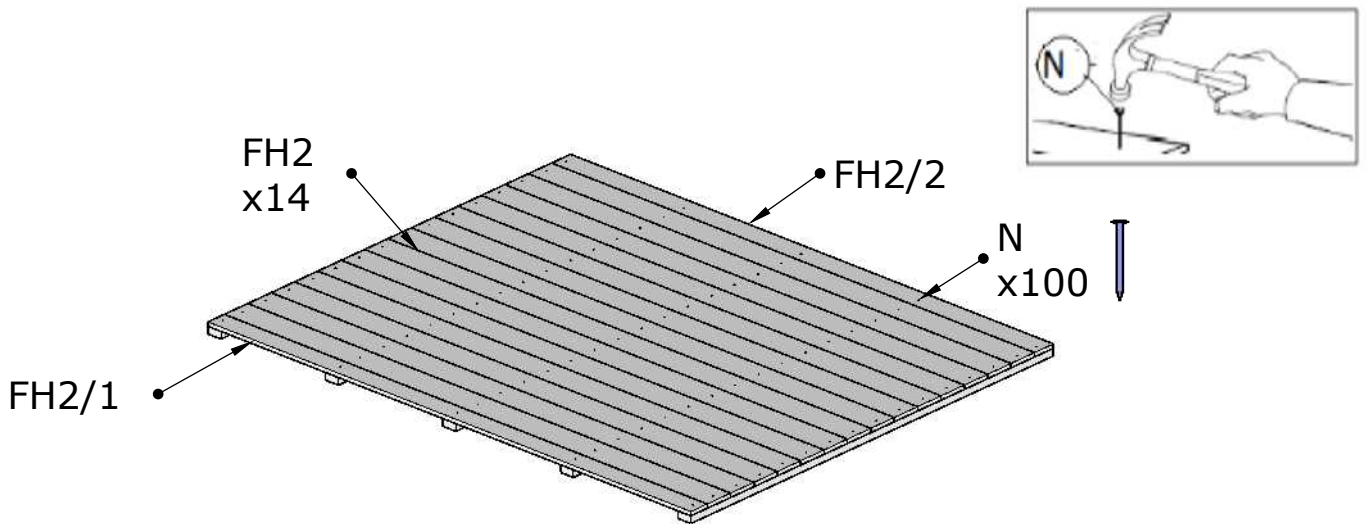

FH2	16x114x2170	14
FH2/1	16x80x2170	1
FH2/2	16x80x2170	1
N	2,2x50	100

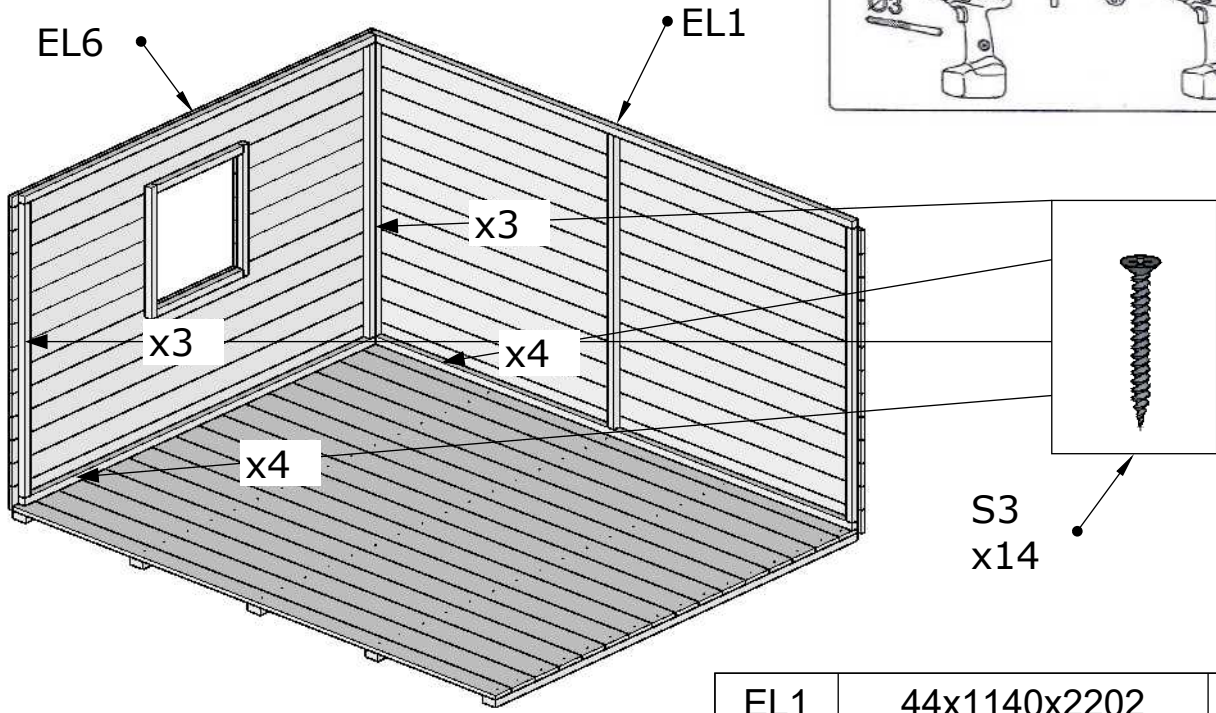

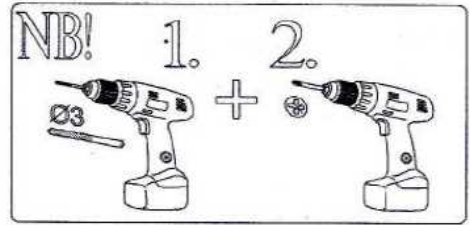

EL1	44x1140x2202	1
EL6	44x1140x1768	1
S3	4,0x50	31
EL2	44x580/1160x2202	1
EL7	44x1140x1768	1
EL8	44x580x1768	1

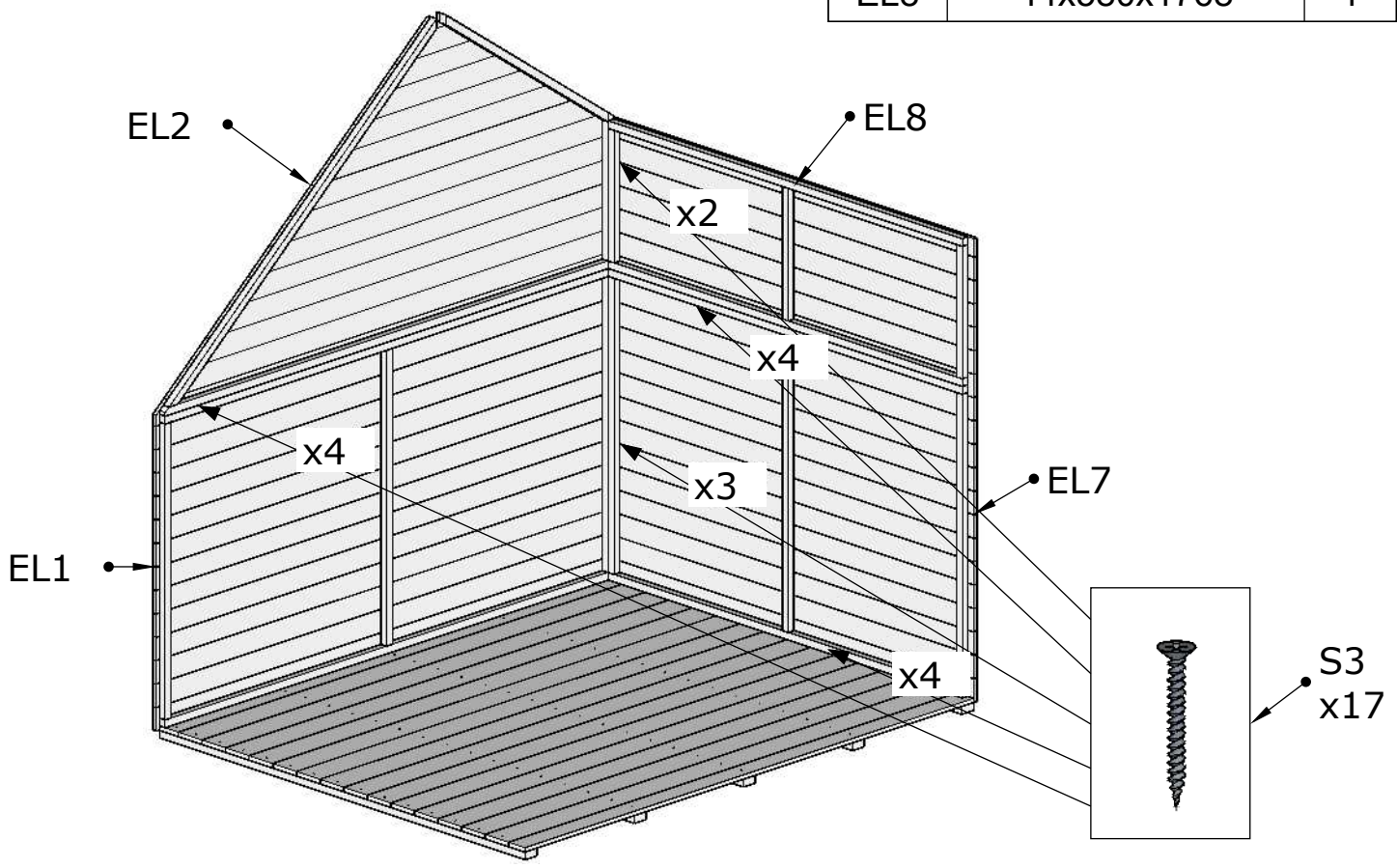

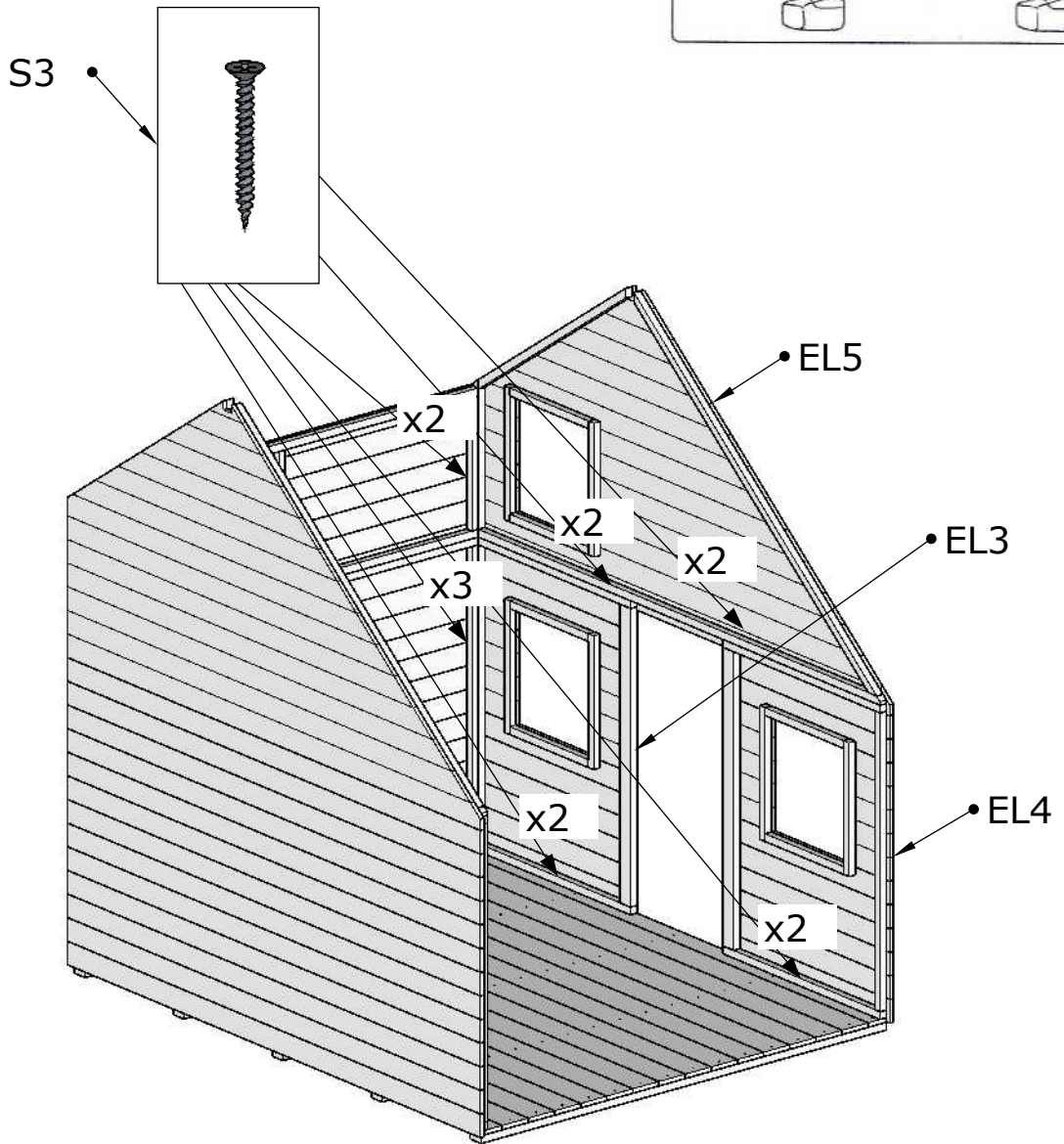
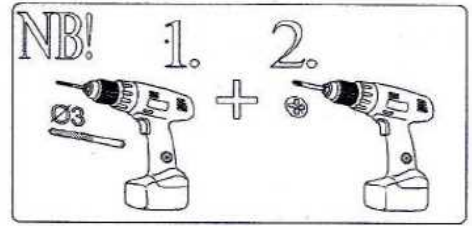

EL3	44x855x1140	1
EL4	44x855x1140	1
EL5	44x580/1160x2202	1
S3	4,0x50	13

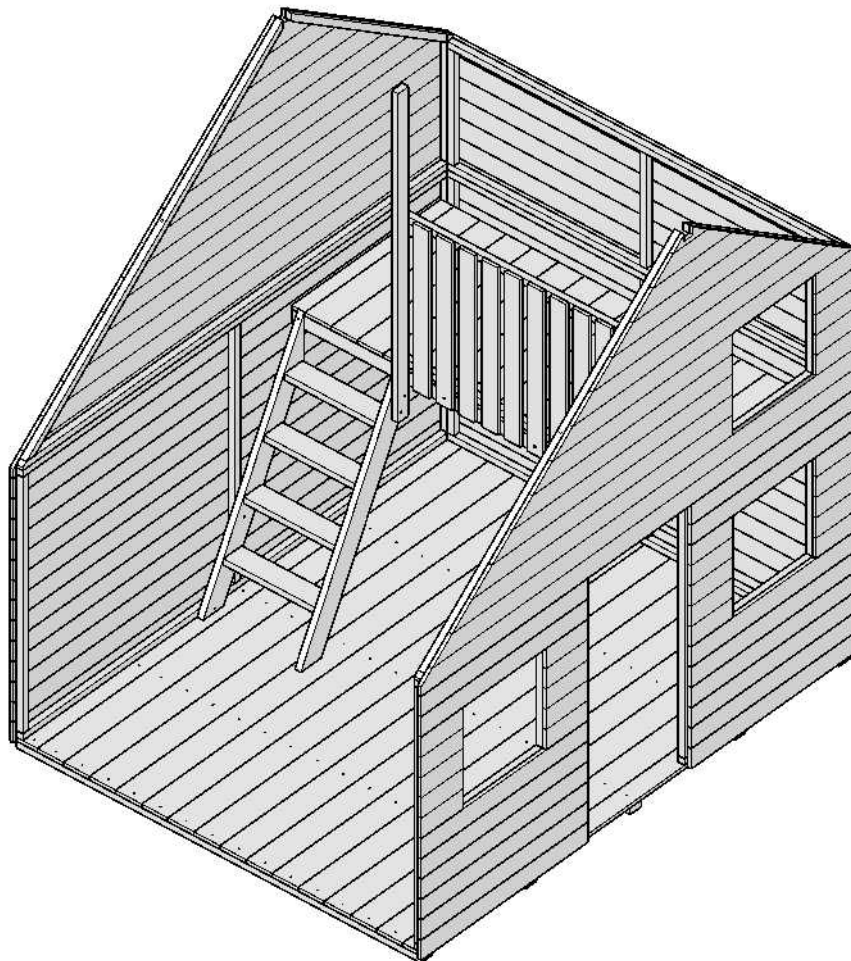
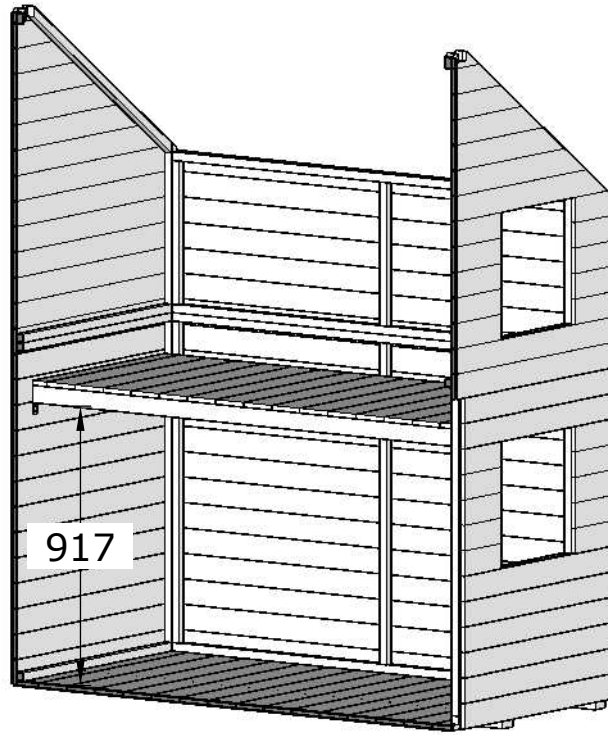

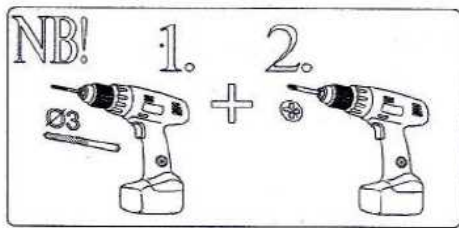
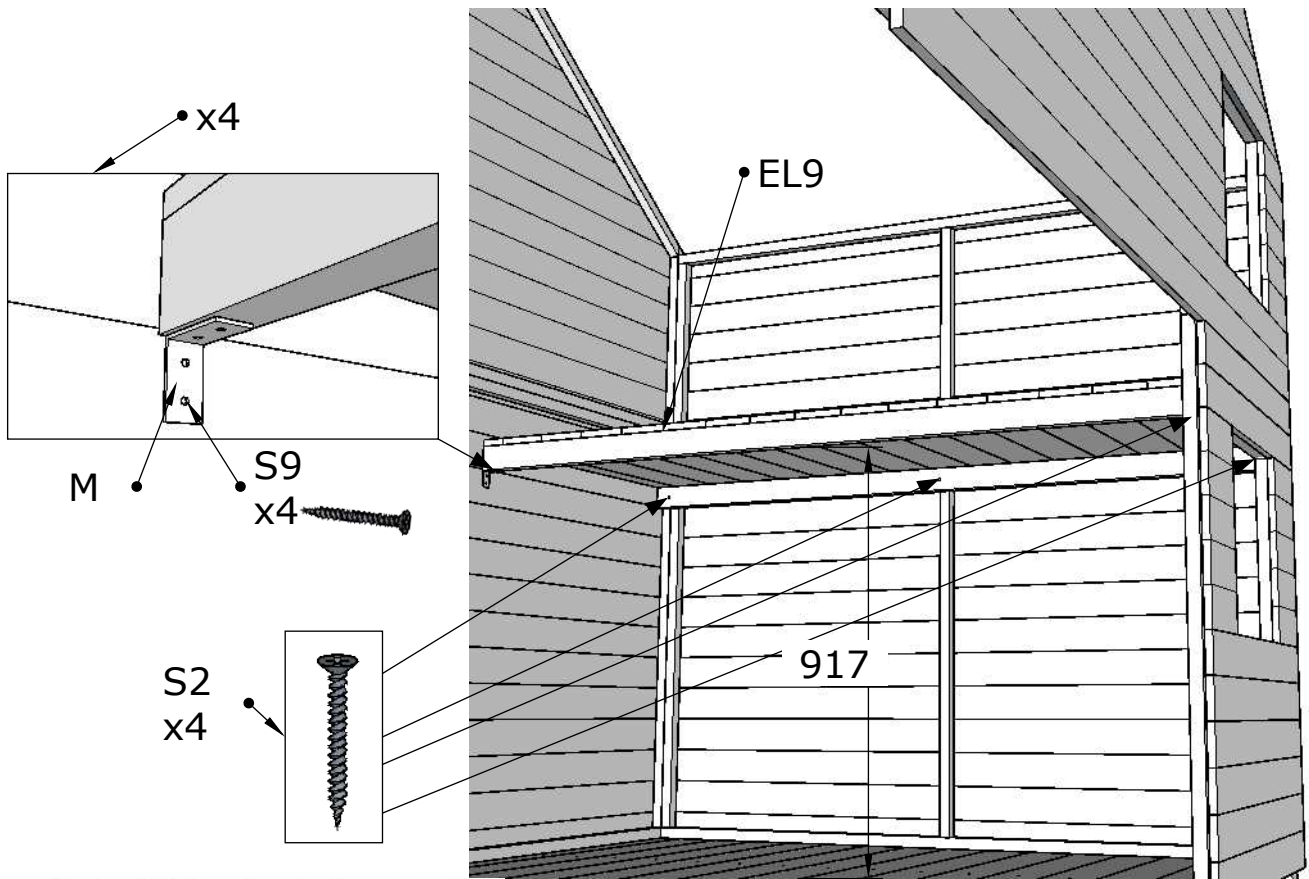

EL9	74x752x1766	1
M	40x40x20	4
S2	4,0x60	4
S9	3,5x15	16

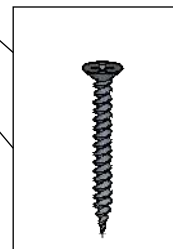
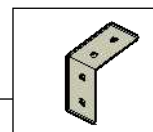

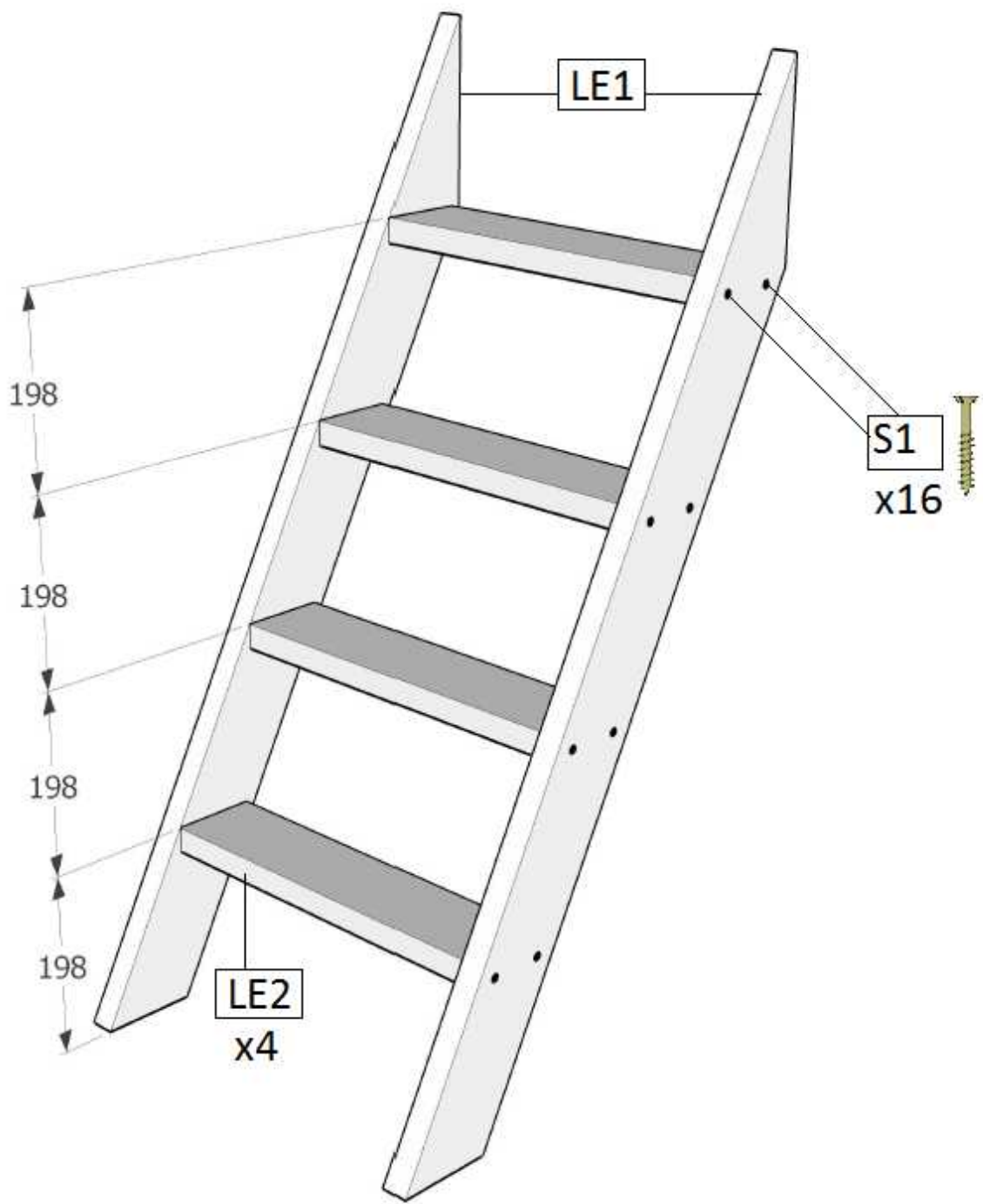

LE1	28x90x1115	2
LE2	28x90x400	4
S1	4,5x70	16

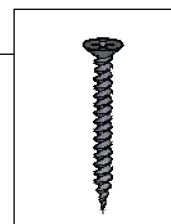

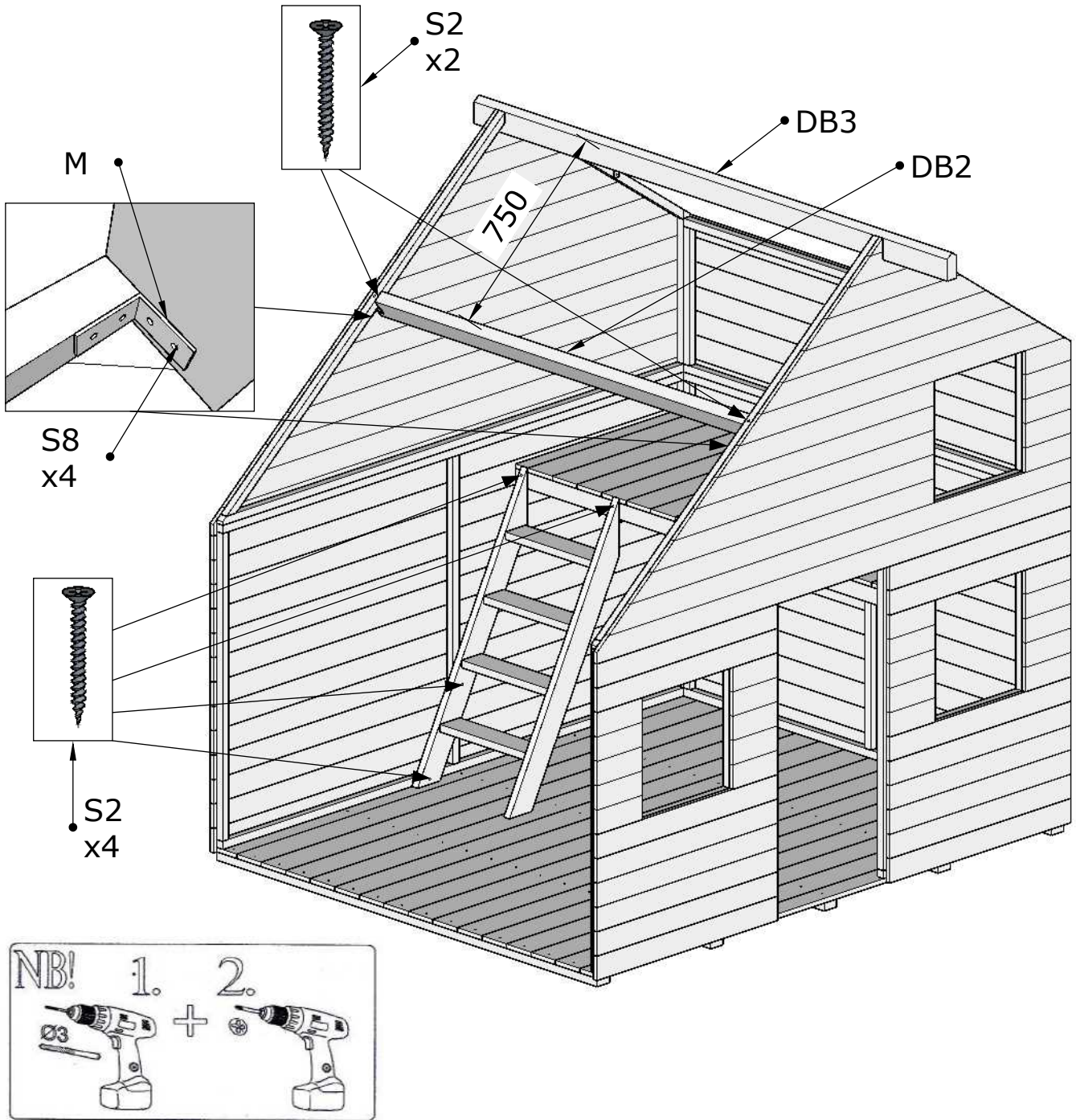

DB2	44x94x1768	1
DB3	44x94x2200	1
S2	4,0x60	6
S8	3,5x25	8
M	40x40x20	2

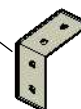
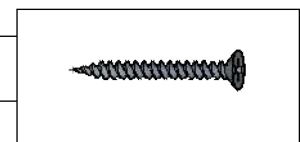

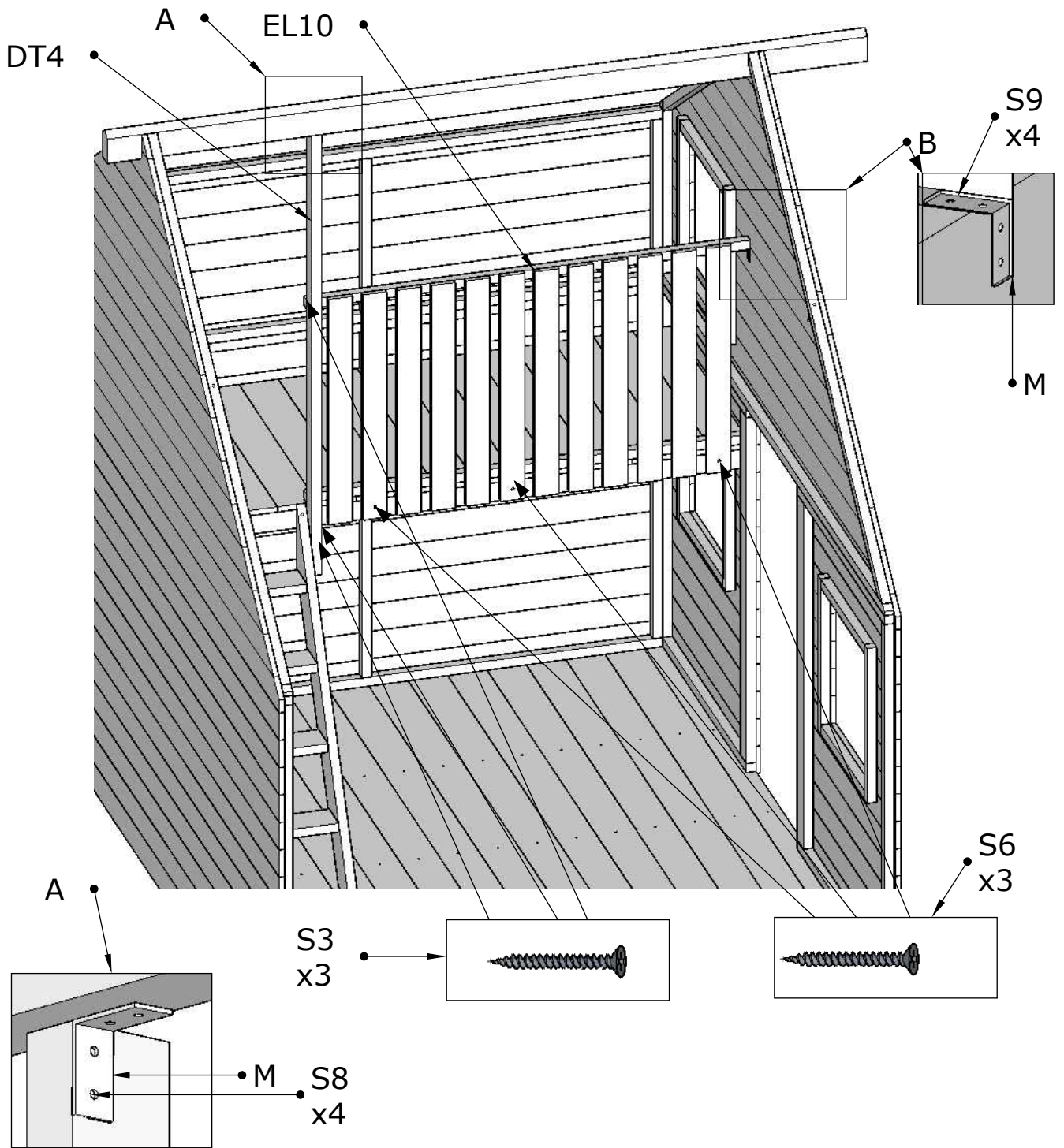

EL10	42x690x1284	1
DT4	28x58x1375	1
M	40x40x20	2
S3	4,0x50	3
S6	3,5x35	3
S8	3,5x25	4
S9	3,5x15	4

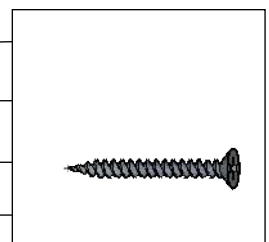
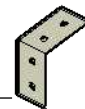

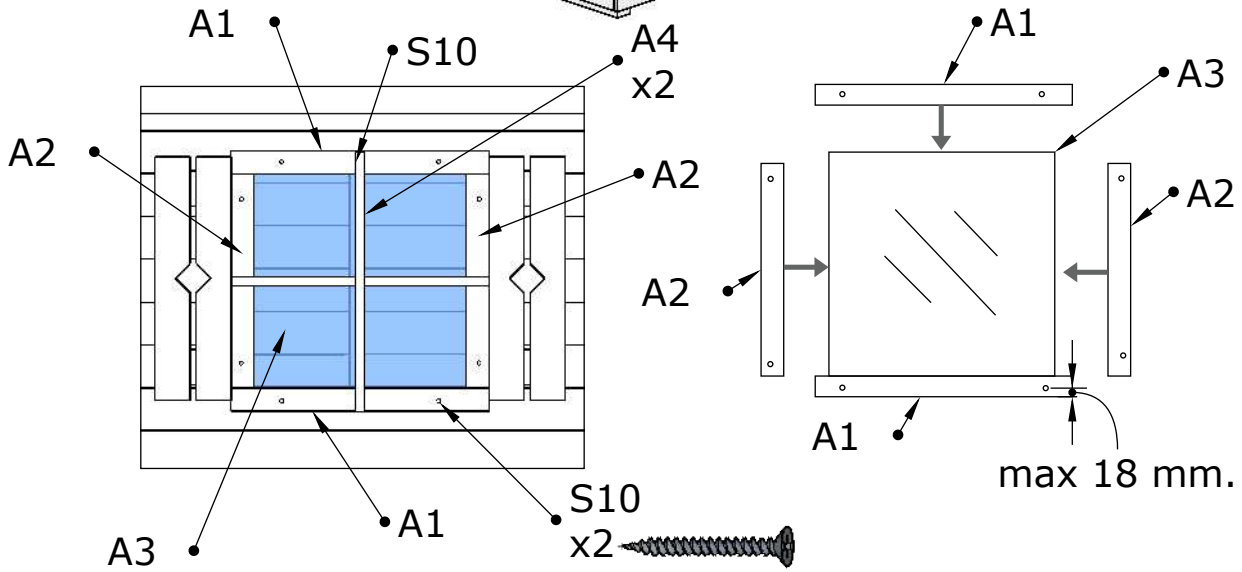
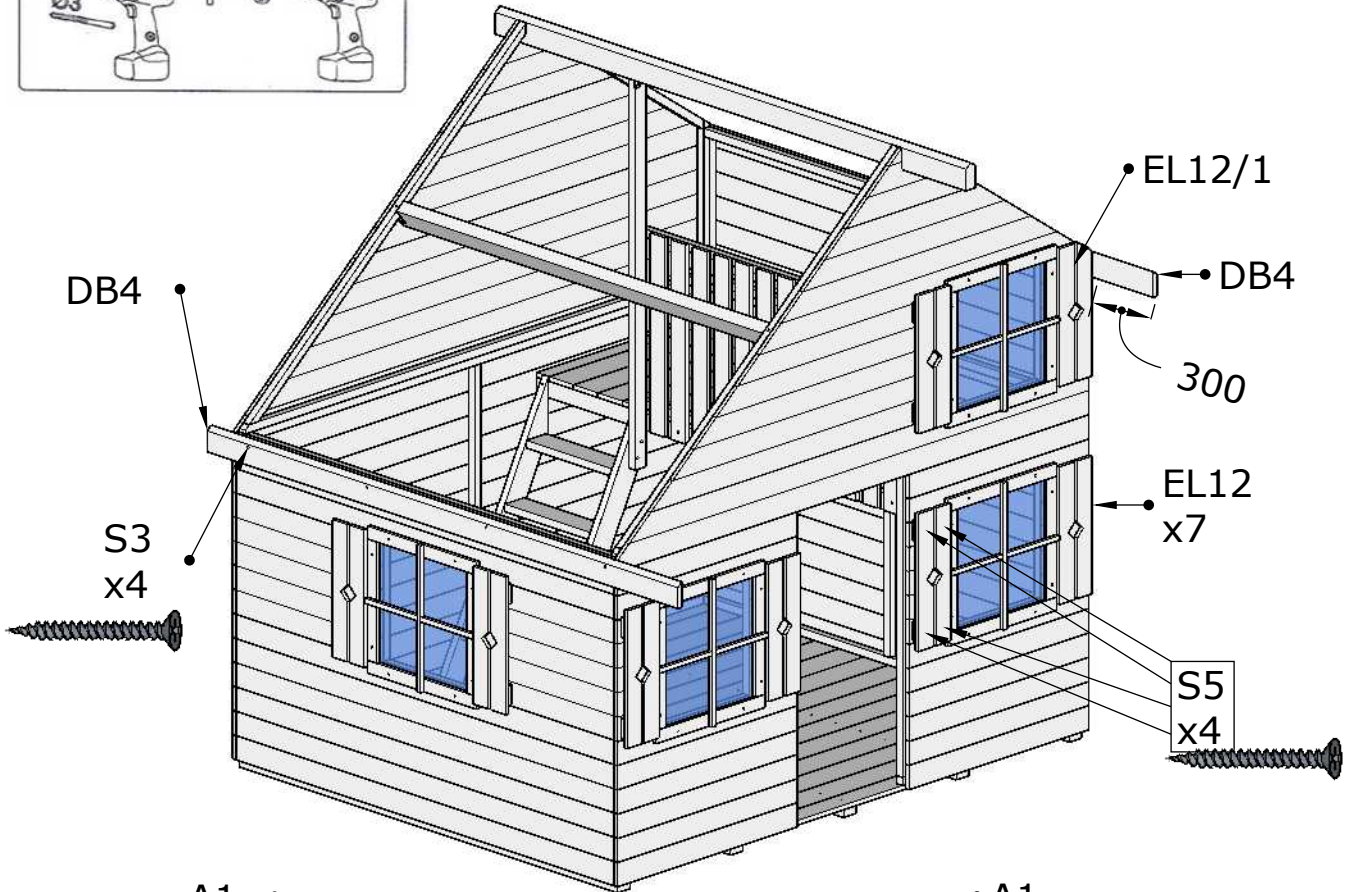
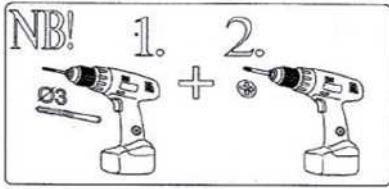

DB4	19x90x2200	2
EL12	28x150x480	7
EL12/1	28x150x480	1
S3	4,0x50	8
S5	3,5x40	32
S10	3,0x25	48

A1	15x45x510	8
A2	15x45x420	8
A3	1,5x455x455	4
A4	15x17x510	8

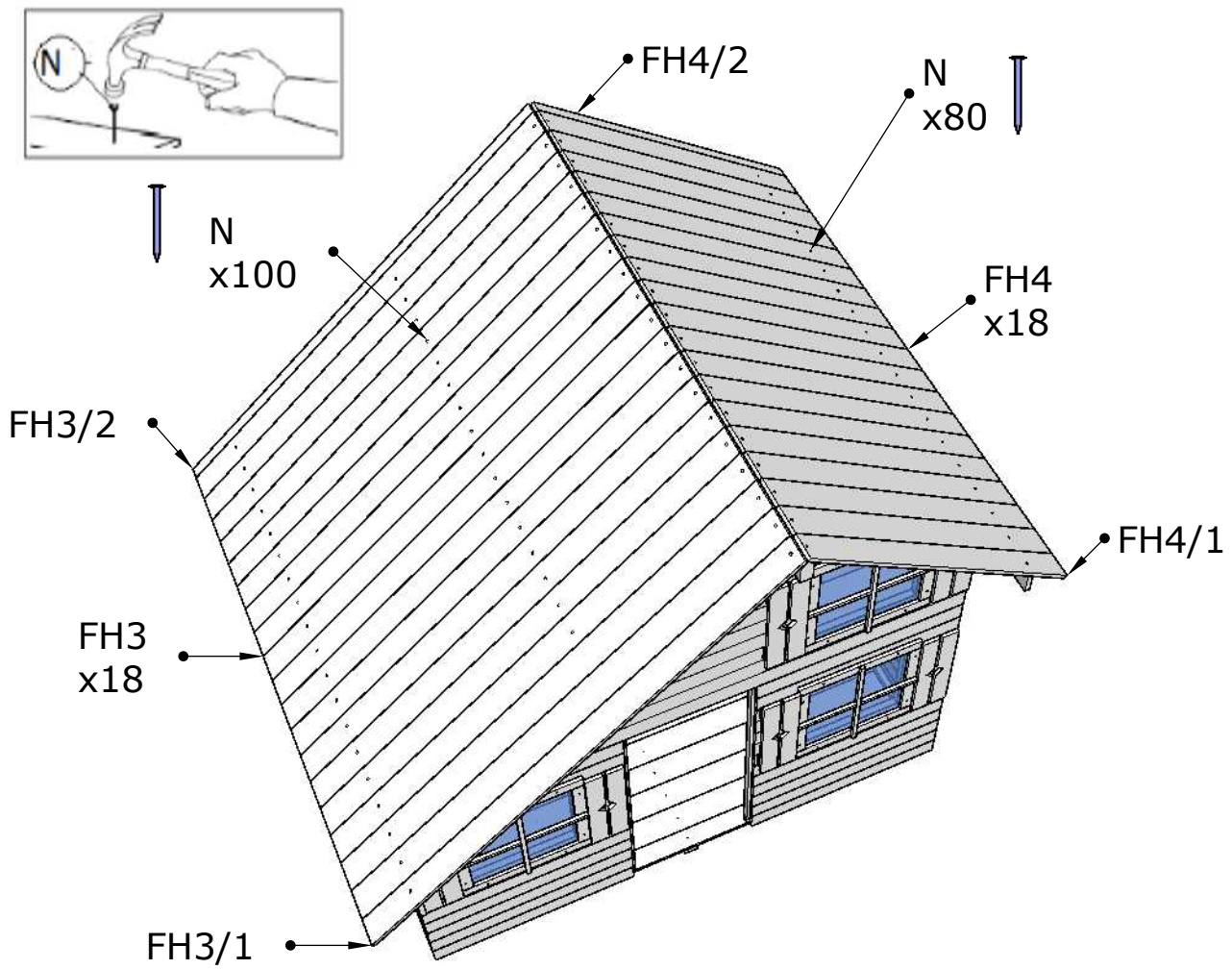

FH3	16x114x2010	18
FH3/1	16x70x2010	1
FH3/2	16x70x2010	1
FH4	16x114x1235	18
FH4/1	16x70x1235	1
FH4/2	16x70x1235	1
N	2,2x50	180

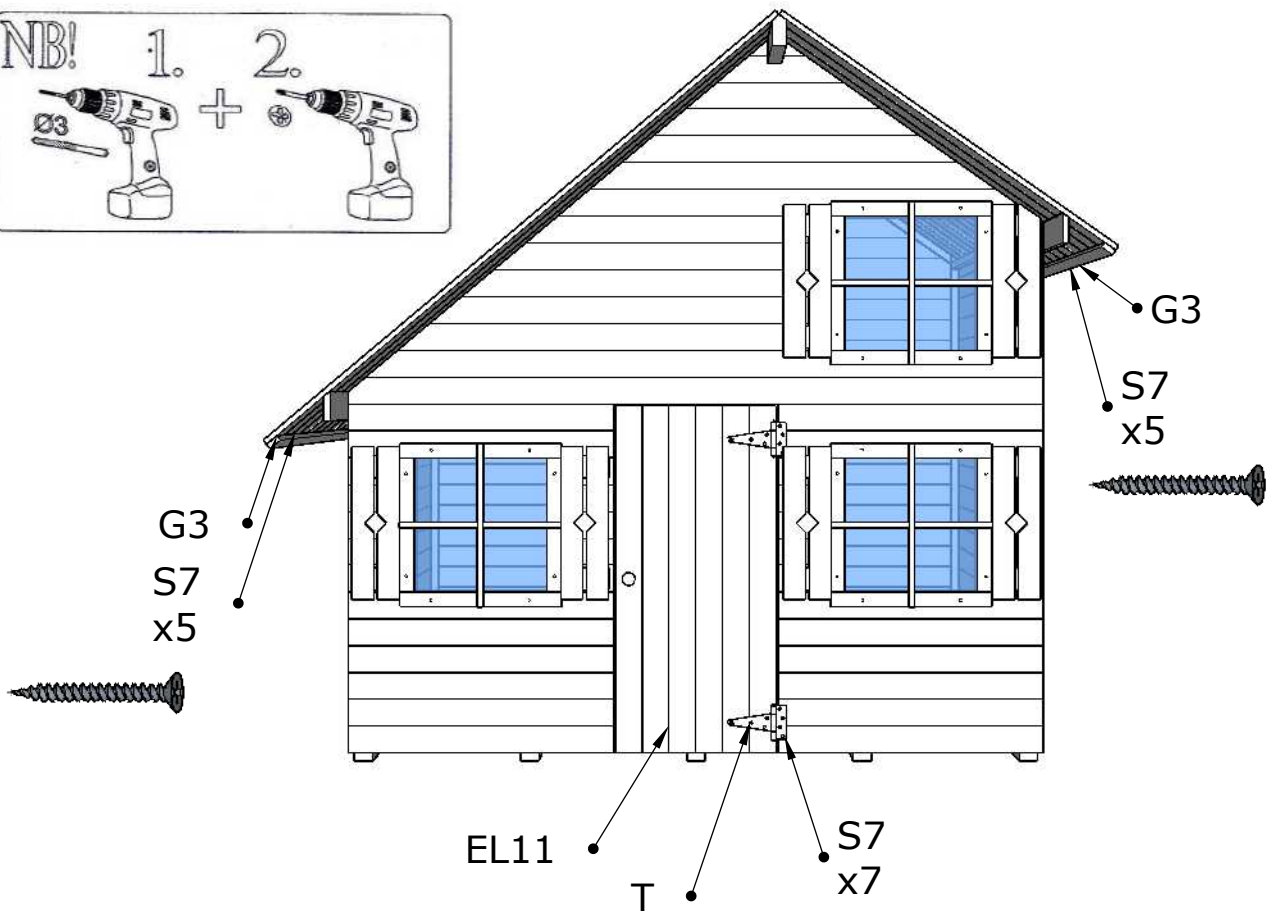
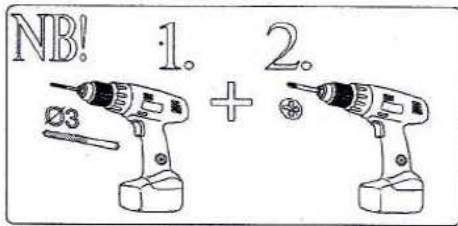

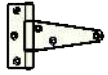
G3	17x40x220	2
EL11	44x510x1100	1
T		2
S7	3,5x30	24



P		2
---	---	---

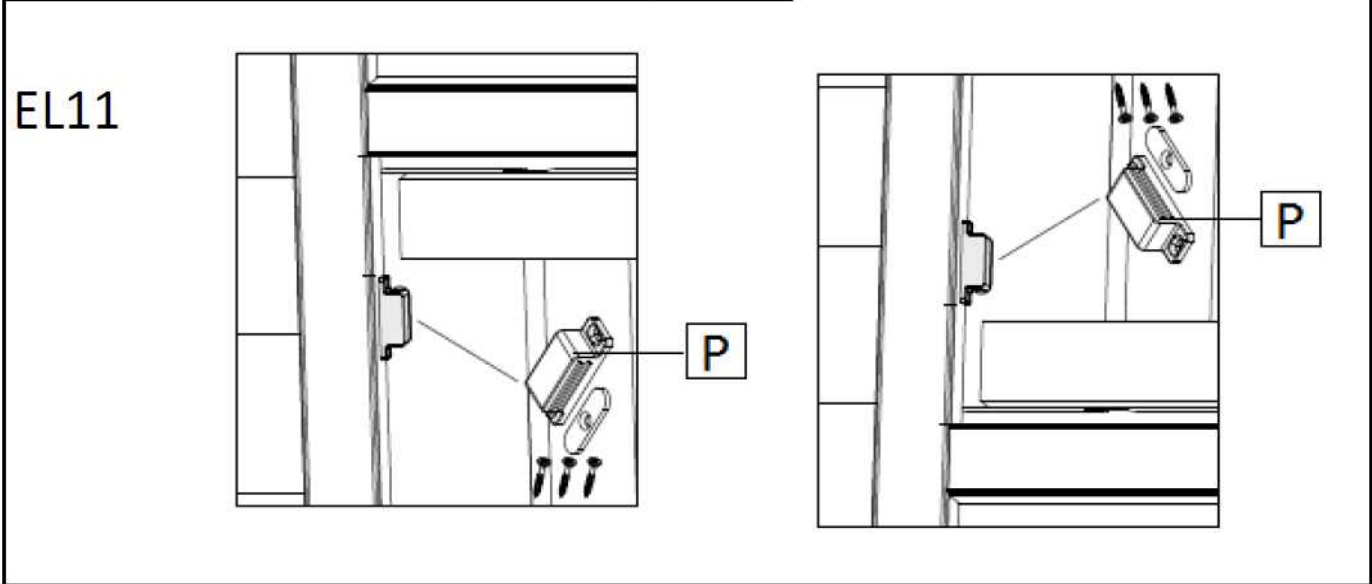

BK1	19x90x480	9
BK2	19x90x180	6
S5	3,5x40 	36

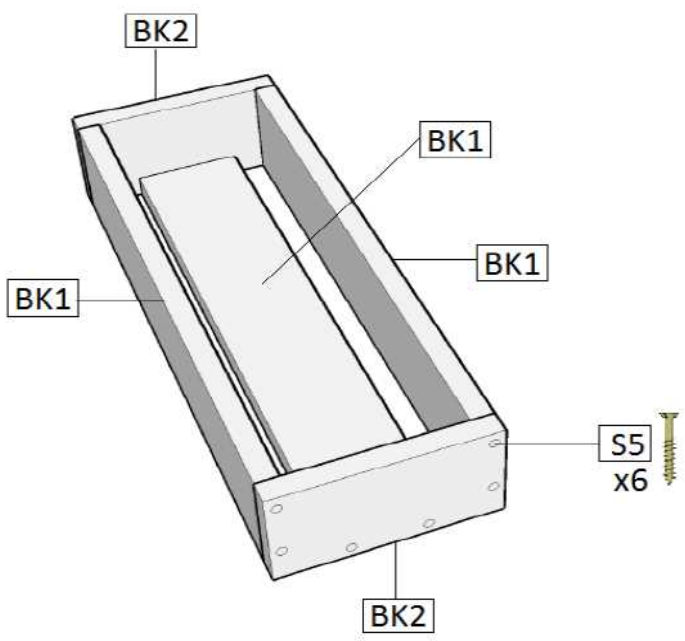
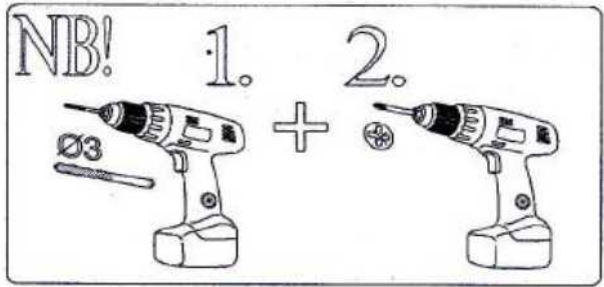

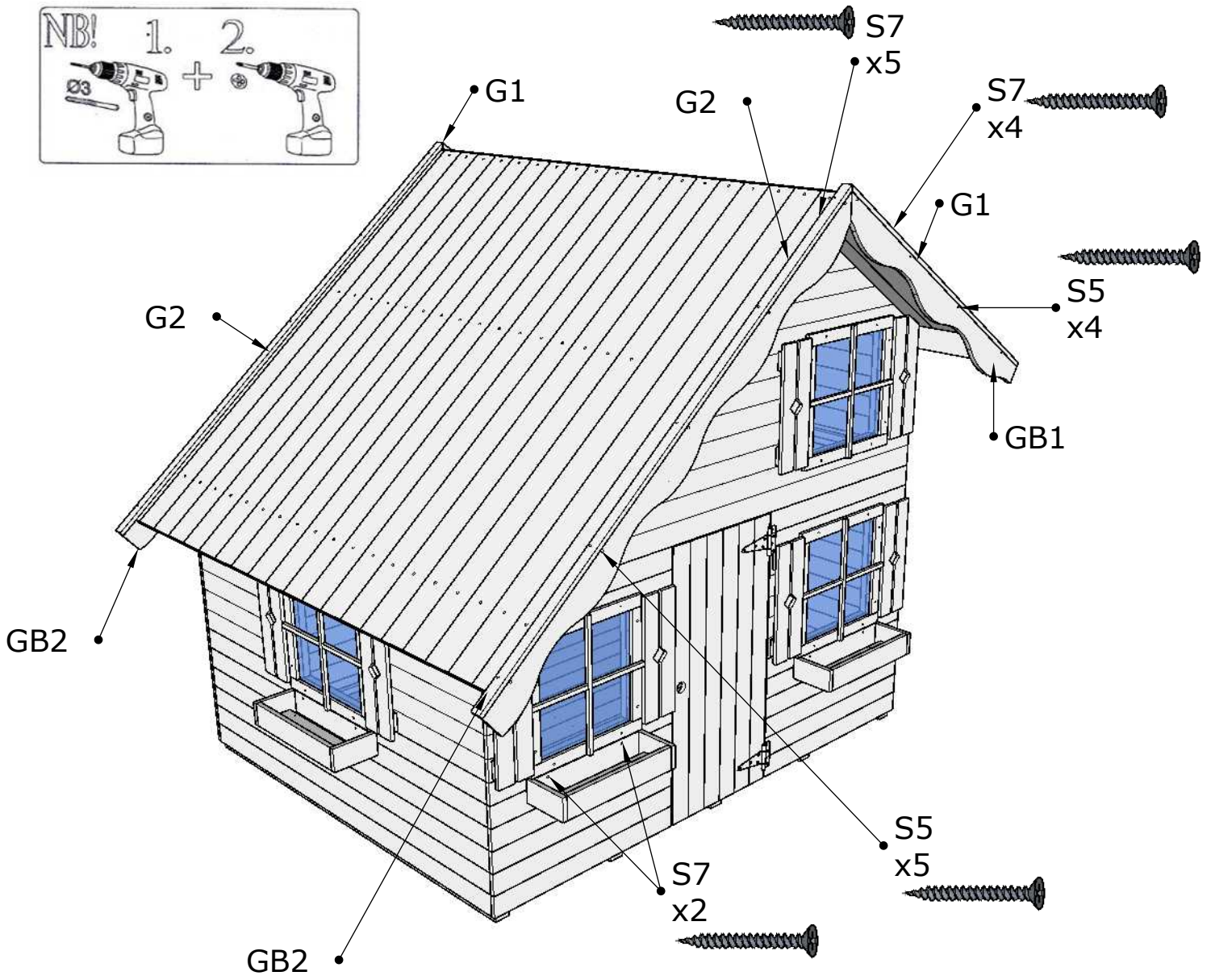
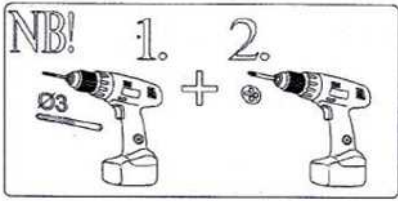

GB1	19x120x1340	2
GB2	19x120x2100	2
G1	17x40x1350	2
G2	17x40x2110	24
S5	3,5x40	18
S7	3,5x30	24



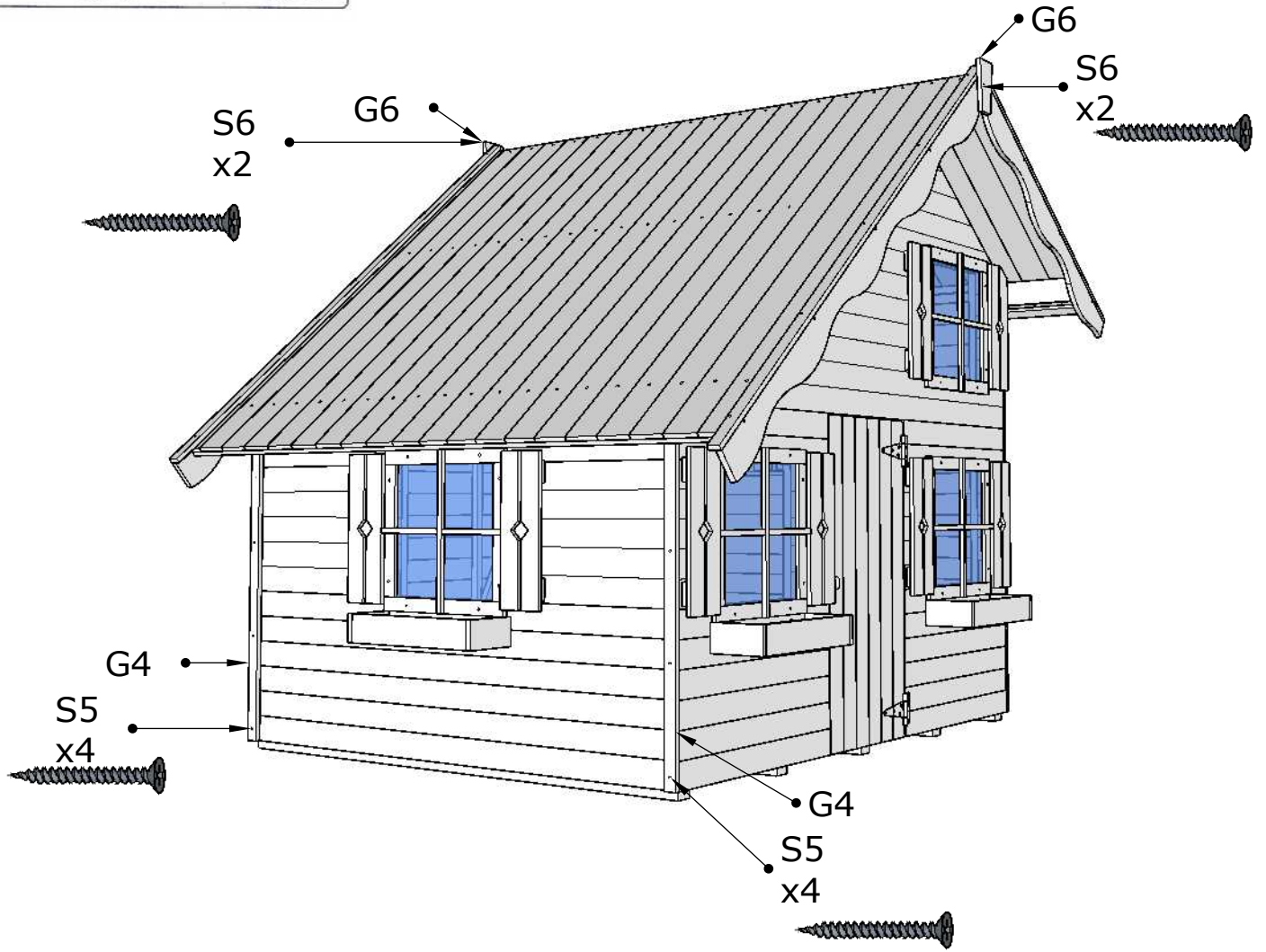
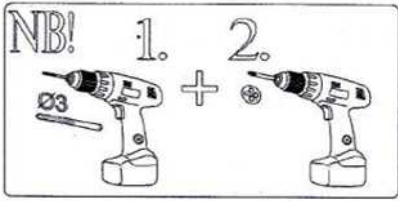

G4	14x66x1055	2
G6	15x90x180	2
S5	3,5x40	8
S6	3,5x35	4



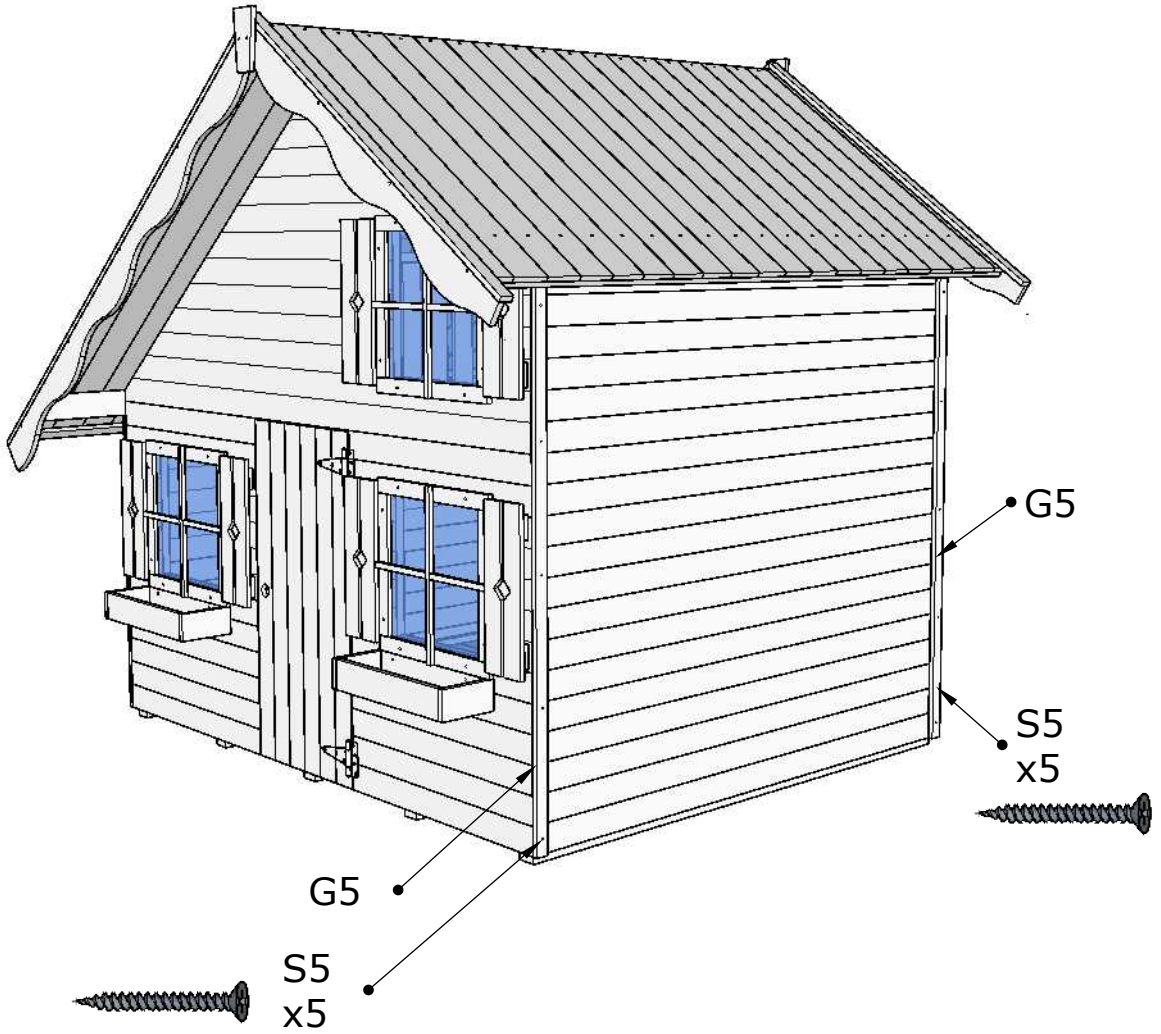
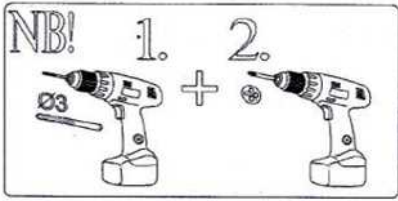

G5	14x66x1590	2
S5	3,5x40	10

